

JVC

SERVICE MANUAL

MODEL
R-S77

DIGITAL SYNTHESIZER
STEREO RECEIVER
Super-A

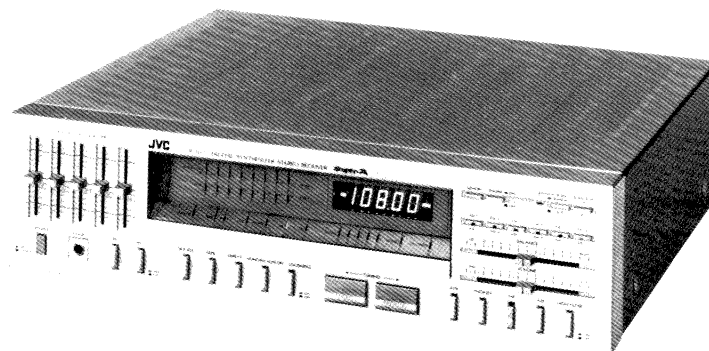

No. 2520
FEB. 1980

Contents

1. Specifications	1	10. Printed Circuit Board Ass'y and Parts List	
2. Names and Their Functions		10-(1) TXX-267 Main Amp., Power Supply and Other Functions Split P.C. Board Ass'y	10
2-(1) Front Panel	2	10-(2) TXX-268 Equalizer, S.E.A. and Other Functions Split P.C. Board Ass'y	13
2-(2) Rear Panel	3	10-(3) TXX-269 Logic and Counter P.C. Board Ass'y	15
3. Removal Procedures		10-(4) TAP-283 S.E.A. Control P.C. Board Ass'y	17
3-(1) Top Cover and Bottom Plates	4	10-(5) TFM-924 FM/AM Tuner P.C. Board Ass'y	18
3-(2) Power Transistors	4	11. Accessories List	21
4. Main Parts Location		12. Packing Materials and Part Numbers	21
4-(1) Top View	5	13. R-S77 Schematic Diagram	22
4-(2) Front View	5	14. Parts List with Specified Numbers for Designated Areas	24
4-(3) Rear View	5		
5. Exploded View and Part Numbers	6		
6. Block Diagram of Digital Synthesizer	7		
7. Pin-plug to Pin-jack Connections Diagram	7		
8. FM/AM Tuner Alignment Procedures			
8-(1) FM Section	8		
8-(2) AM Section	9		
9. Power Amplifier Idling Current Adjustment Procedure	9		

Warning:

When replacing the parts marked with \triangle , be sure to use the designated parts to ensure safety.

1. Specifications

FM Tuner Section (Figures are based upon IHF Standard)

Tuning Range	: *87.9 MHz – 107.9 MHz (87.5–108.0 MHz for 50 KHz step)
Usable Sensitivity (IHF)	: 10.3 dBf (1.8 μ V/300 Ω)
50 dB Quieting Sensitivity	
Mono	: 14.8 dBf (3 μ V/300 Ω)
Stereo	: 37.2 dBf (40 μ V/300 Ω)
Distortion	
Mono	: 0.15 % (1 kHz)
Stereo	: 0.3 % (1 kHz)
Signal to Noise Ratio	
Mono	: 80 dB (68 dB, DIN)
Stereo	: 70 dB (62 dB, DIN)
Selectivity	: 80 dB, \pm 400 kHz (65 dB, 300 kHz, DIN)
Capture Ratio	: 1.0 dB
IF Rejection	: 100 dB at 98 MHz
Image Rejection	: 78 dB at 98 MHz
Stereo Separation	: 45 dB at 1 kHz
AM Tuner Section	
Tuning Range	: *530 kHz – 1620 kHz (522 kHz–1611 kHz for 9 kHz step)
Usable Sensitivity	: 250 μ V/m, 50 μ V (External Antenna)
Signal to Noise Ratio	: 50 dB
Distortion	: 0.5 % at 10 mV/m
Selectivity	: 63 dB \pm 10 kHz (60 dB \pm 9 kHz, DIN) (Note) *U.S.A. & CANADA

Amplifier Section

RMS Power	: 60 W per channel at 8 Ω (Both channels driven, from 20 Hz to 20 kHz with 0.005 %)
RMS Power	: 65 W per channel at 8 Ω (Both channels driven, at 1 kHz)
Total Harmonic Distortion	: 0.005 % at rated power 20 Hz – 20 kHz, 8 Ω 0.001 % at rated power 1 kHz, 8 Ω
Input Sensitivity/Impedance	
Phono	: 2.5 mV/47 k Ω
Aux	: 180 mV/43 k Ω
Tape Play	: 180 mV/43 k Ω (180 mV/43 k Ω , DIN)
S.E.A. Graphic Equalizer	
Center Frequencies	: 40 Hz, 250 Hz, 1 kHz, 5 kHz and 15 kHz
Control Range	: \pm 12 dB
Signal to Noise Ratio	: Phono 77 dB (IHF short-circuited A network)
	: (New IHF 75 dB) Tape Play 98 dB (New IHF 75 dB)
Power Consumption	: See page 24

Design and specifications subject to change without notice.

Dimensions and Weight

Areas	Dimensions			Weight Net
	Height	Width	Depth	
U.S.A., Canada & U.S. Military Market	12.0 cm (4-23/32")	48.0 cm (18-29/32")	38.2 cm (15-1/16")	10.8 kg (23.8 lbs.)
All Other Countries	11.9 cm (4-11/16")	45.2 cm (17-13/16")	38.2 cm (15-1/16")	10.6 kg (23.3 lbs.)

2. Names and Their Functions

2-(1) Front Panel

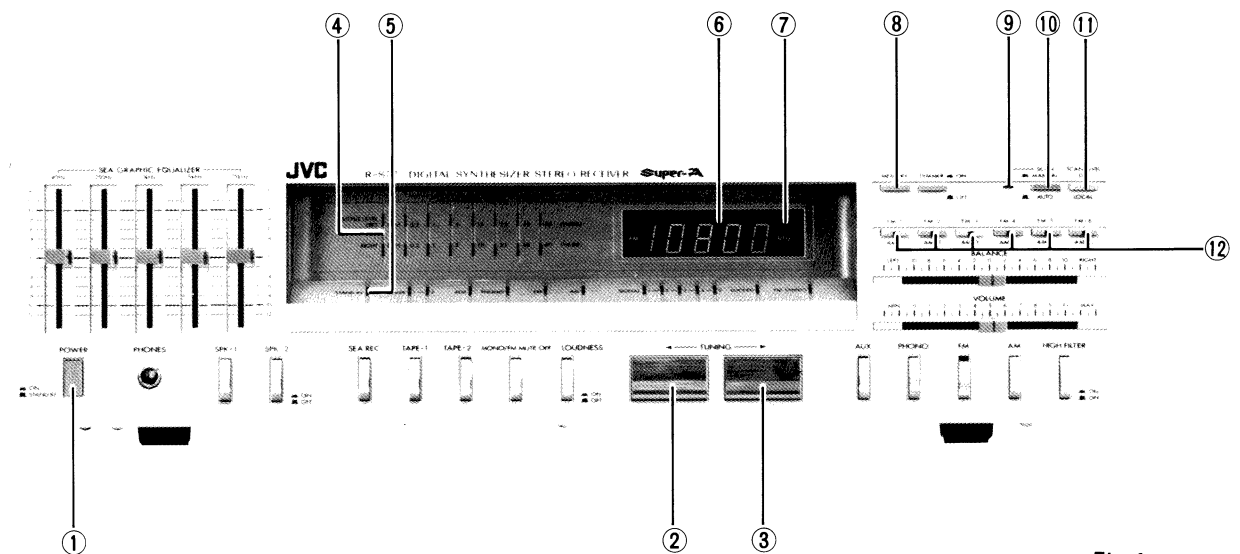

Fig. 1

① POWER switch

ON: Press to turn the power on. During the first 3 or 4 seconds after the POWER switch is turned on, no sound will be heard until you hear the "click" of the relay operation. This is not due to any defect in the unit. The built-in power protection circuit operates to mute the switching noise for speaker protection.

STAND BY: When the power cord is plugged into an AC outlet, the STAND BY indicator (5) lights to show that the memory circuit is operating. As long as this indicator remains lit, the preset stations are not subject to cancellation or alteration. The preset data are maintained even in the case of a power failure or when the power cord is disconnected, if the period of non-applied power does not exceed a couple of days.

②③ TUNING buttons

Auto tuning

Up-scanning button: When this button is pressed, the tuned-in frequency changes in the direction of increasing frequencies. Use this button to search the upper frequency broadcast. Scanning (Auto Tuning) stops automatically when the next FM (or AM) station is pulled in. This tuned-in frequency is displayed digitally by the frequency indicator.

Even if you continue to press this button, scanning stops at some stations that can be tuned-in, but if it is not your desired station, press the Up button again. Press the Up-scanning button and then press the Down-scanning button to select stations by down-scanning.

Down-scanning button: Press to tune in the direction of decreasing frequencies. Use this button to search the lower frequency station. Functions are identical with those of the up-scanning button.

Note: Scanning begins by pressing the Up or Down button, re-depressing it stops scanning.

Manual tuning

Manual tuning is possible by pressing the Auto-Manual scanning switch (10). Pressing the Up-Down-scanning buttons, the tuned-in frequency changes in 200 kHz steps for FM reception (50 kHz steps for Europe and Australia) or 10 kHz steps for AM (9 kHz steps for Europe and Australia). Tapping this button changes the tuner step by step, continuous pressing (more than 0.5 sec.) changes tuning in a high speed scanning sequence which stop when released.

④ Left and right channel power indicator

These LED's indicate the output power in watts. The values in watts are indicated per channel when one pair of speakers having an impedance of exactly 8 ohms is being driven.

⑤ STAND BY indicator

Lights when the POWER switch (1) is set to OFF (STAND BY).

⑥ Frequency indicator

The tuned-in frequency is displayed digitally. Four digits (kHz) are displayed for AM reception and five digits (MHz) (for continental Europe) or four digits (MHz) (for U.S.A., Canada and other countries) are displayed for FM reception.

⑦ MEMORY indicator

When the MEMORY button is pressed, this MEMORY indicator lights to show that the unit is ready to register the preset station to memory.

⑧ MEMORY switch

Press this switch and the memory indicator will light to show that this unit is ready to receive a memory setting. (This switch is a non-lock type.) Pressing the station select button while the MEMORY indicator is lit (for about 5 sec.) makes it possible to memorize the station being received. When the MEMORY indicator is not lit, the memory function does not operate.

⑨ Scanning indicator

This green indicator lights when you make auto or manual tuning with the Up or Down buttons (2), (3).

FM/AM OPERATION

⑩ AUTO-MANUAL SCAN switch

Press this switch in for MANUAL tuning and press again to set to the out position for AUTO tuning.

⑪ SCAN LEVEL switch (LOCAL, DX)

Normally this switch is set to LOCAL so that scanning stops automatically upon receiving only those stronger signals. If you want to scan all weak signal stations, set this switch to DX.

⑫ Station select buttons/Station indicators

These buttons are used to select one of the preset stations or to preset the station for an individual channel. When one of these buttons is pressed, the LED indicator on the corresponding button lights to indicate which channel is in operation. If one of these buttons is pressed when the MEMORY switch (8) is pressed in, the station which is being received will be "Memorized". One of the station select buttons can be used in common for one FM station and one AM station.

If you change the mode from radio reception to any other mode including power-off and back to radio reception, the station previously selected with the station select buttons remains tuned in. However, unless the station select buttons are pressed, station indicators will not light, but the scanning indicator will light instead.

Presetting to selected station (FM or AM)

1. Press the POWER switch to ON (—).
2. Press the source select switch FM (or AM) to ON (—).
3. Tune to a desired station by pressing the "TUNING" buttons for AUTO or MANUAL TUNING.
4. Press the MEMORY switch (—). (The memory indicator lights.)
5. Press one of the station select buttons (—).
6. Make the same pre-tuning procedure (steps 3, 4, 5) for the remaining channels. Pre-tuning is possible up to 12 different stations (6 FM stations and 6 AM stations).
7. Press the desired station select button for listening (—). (This indicator on the corresponding button lights to indicate which channel is in operation.)

Listening to FM broadcasts

1. Press the POWER switch to ON (—).
2. Select the speaker system with the SPK-1 or SPK-2 switch.
3. Press the FM button to ON (—).
4. Press the desired station select button (—).
5. Adjust the volume and balance to your requirements and use the S.E.A. controls to obtain the tone you want to hear.

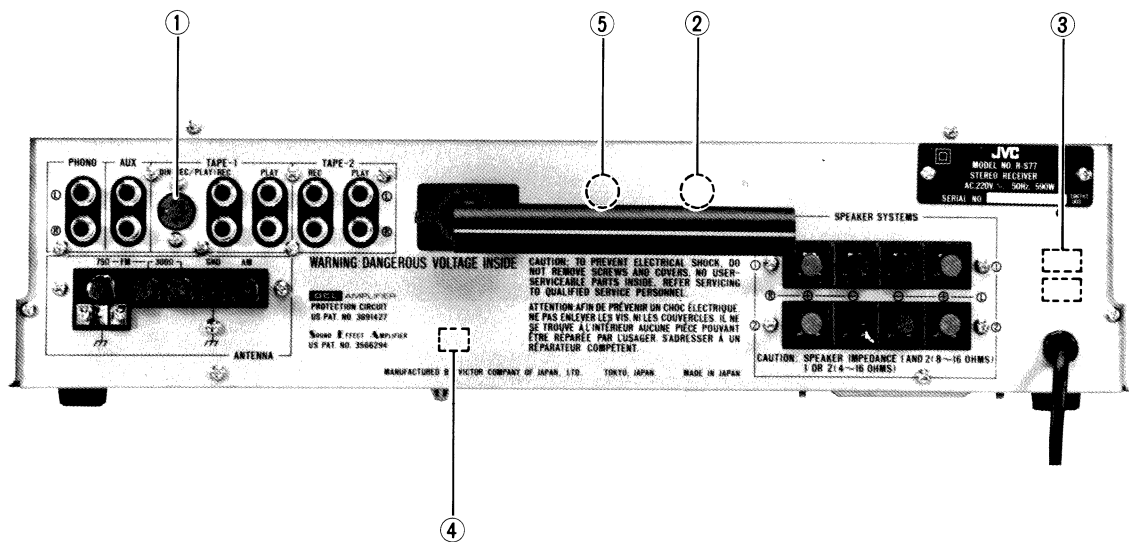

① TAPE DIN socket (REC/PLAY)

(Provided on sets for the Europe, Australia and U.K.)

② Voltage selector

(Not provided on sets for U.S.A., Canada, Europe, Australia and U.K.)

③ AC outlet

(Not provided on sets for Continental Europe, the United Kingdom and Australia.)

④ AM channel spacing switch

(Provided on sets for the U.S.A., Canada, etc. Set this switch according to AM channel spacing of your country.)

⑤ Fuse holder

(Not provided on sets for U.S.A., Canada, Europe, Australia and U.K.)

Note:

- The AC outlet is not switched off by the front panel power switch. Connect it to a component which only uses power when operating, like a record turntable.

3. Removal Procedures

3-(1) Top Cover and Bottom Plates

for U.S.A., Canada and U.S. Military Market

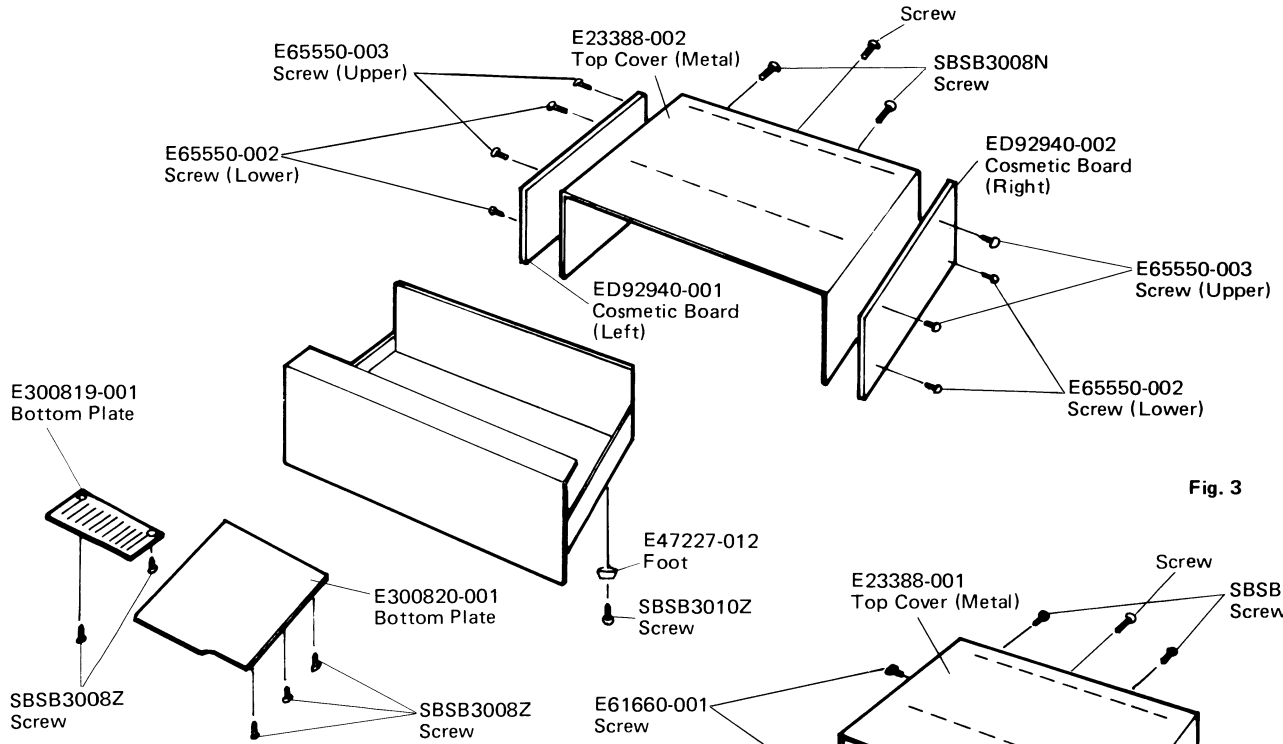

Fig. 3

for All Other Areas

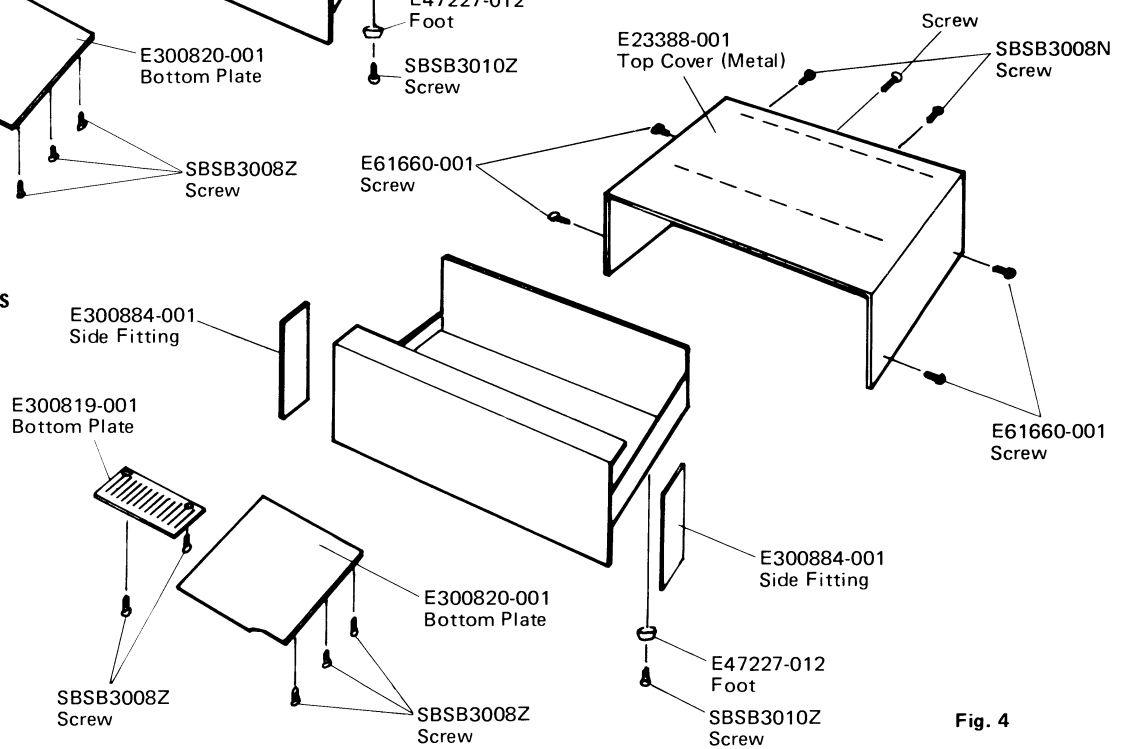

Fig. 4

3-(2) Power Transistors

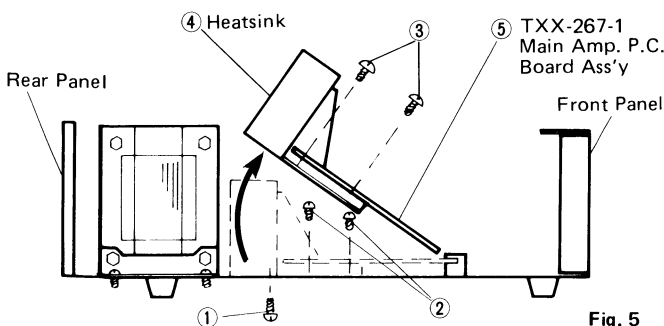

Fig. 5

Procedures:

- Step 1: Remove the bottom plate from chassis and 2 screws ① from heatsink ④.
- Step 2: Remove 4 screws ②.
- Step 3: Raise TXX-267 ⑤ from chassis as arrowed on Fig. 5 and then resolder the power transistor's leads.
- Step 4: Remove 4 screws ③ and heatsink from TXX-267 and then replace the power transistors.

4. Main Parts Location

4-(1) Top View

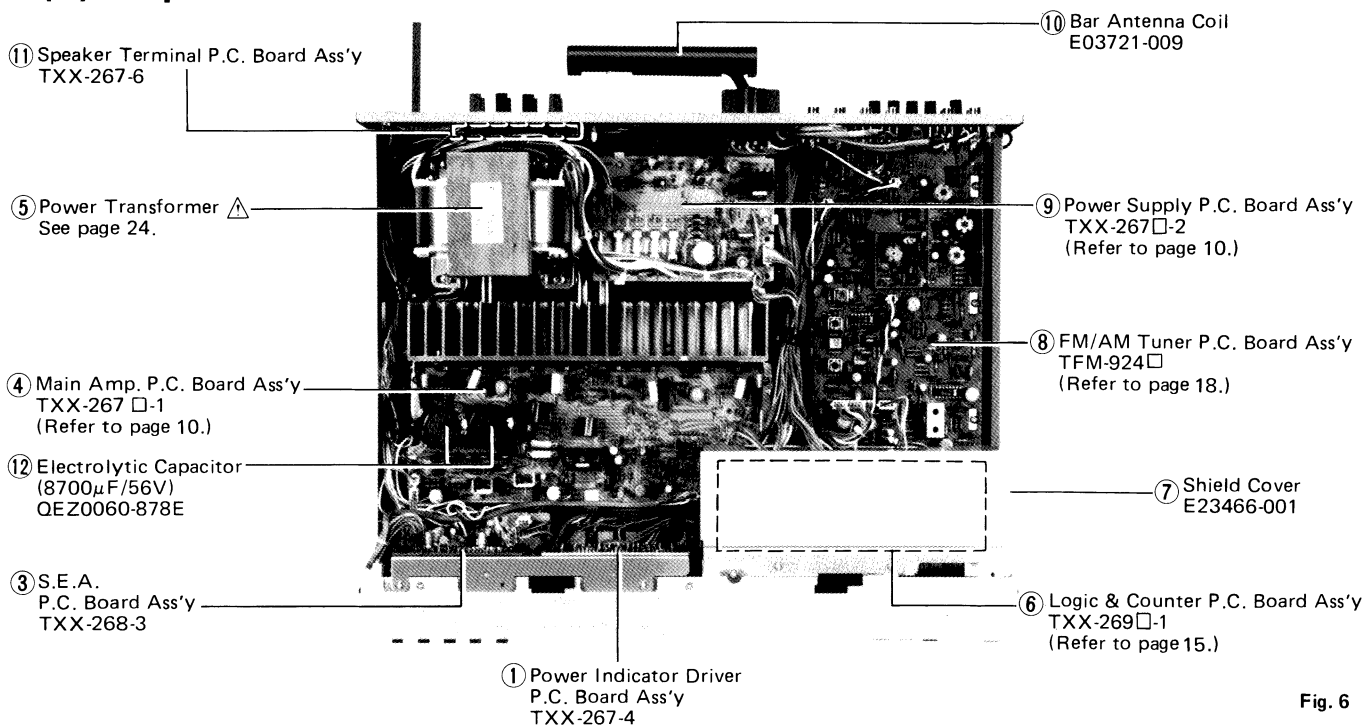

Fig. 6

4-(2) Front View

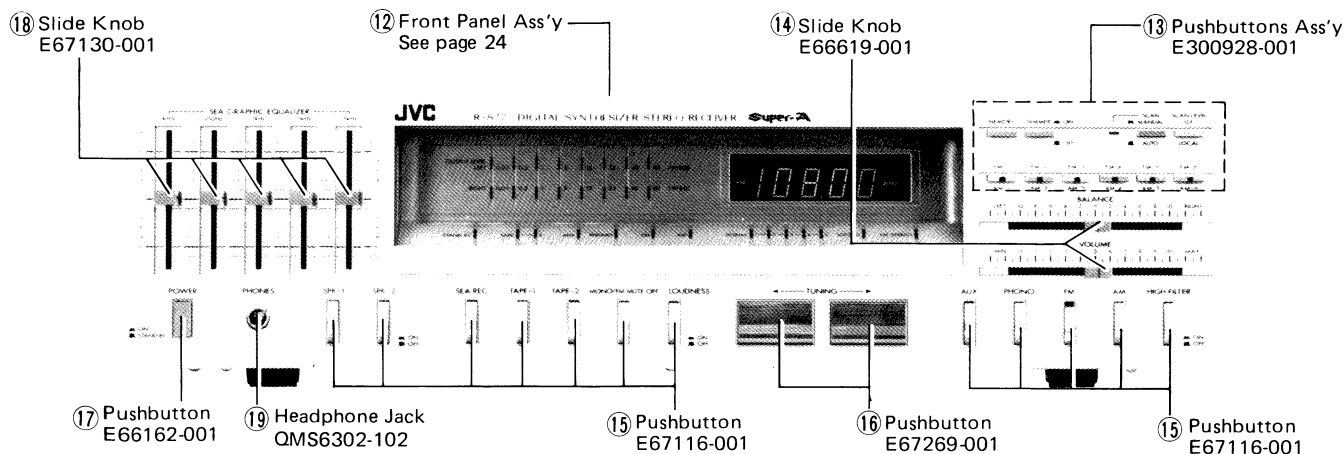

Fig. 7

4-(3) Rear View

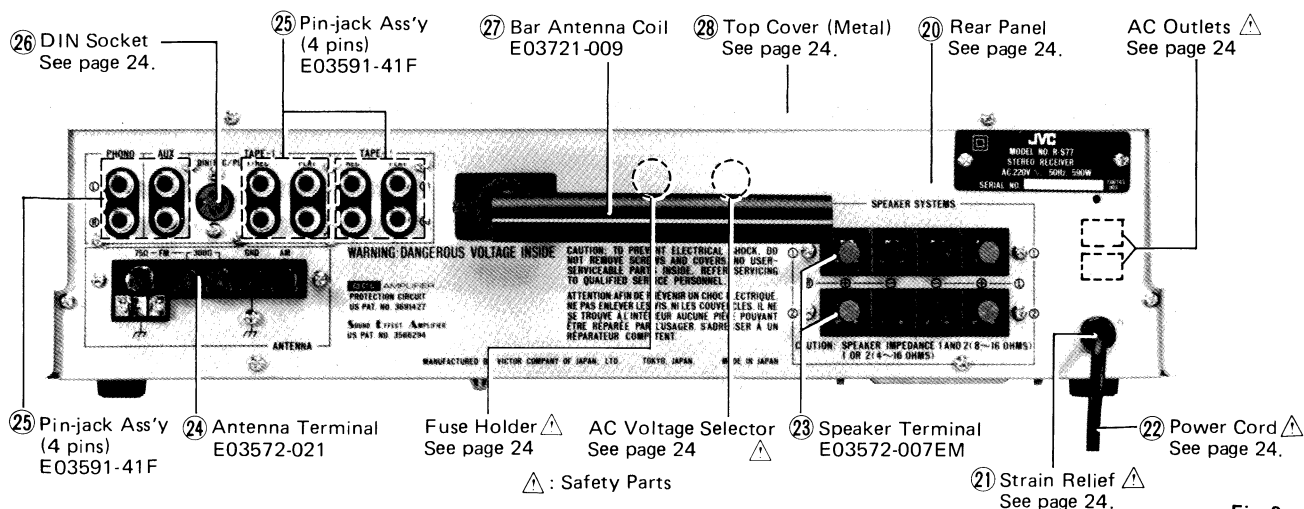

Fig. 8

5. Exploded View and Part Numbers

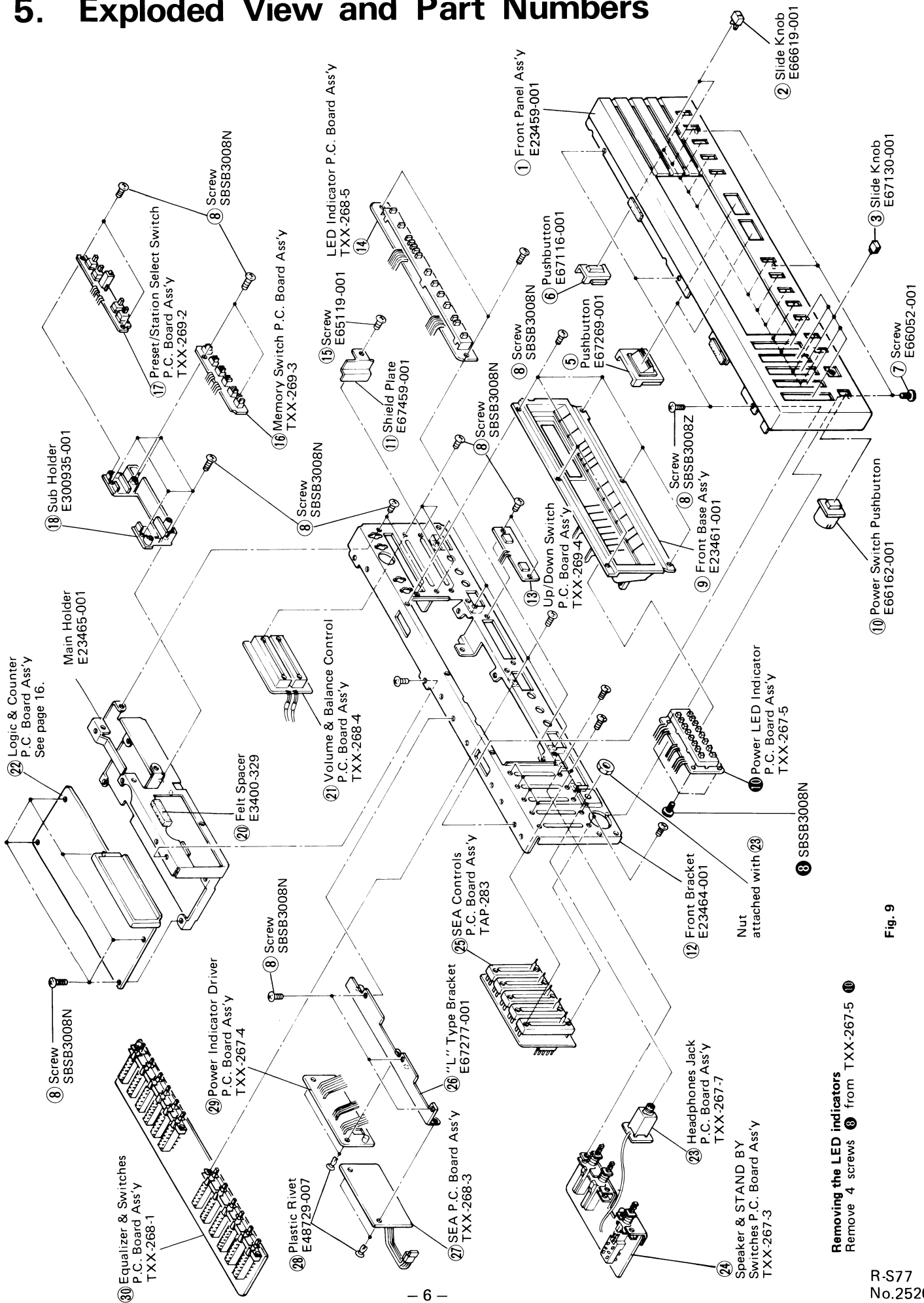

Fig. 9

Removing the LED indicators
Remove 4 screws ⑧ from TXX-267-5 ⑩

6. Block Diagram of Digital Synthesizer

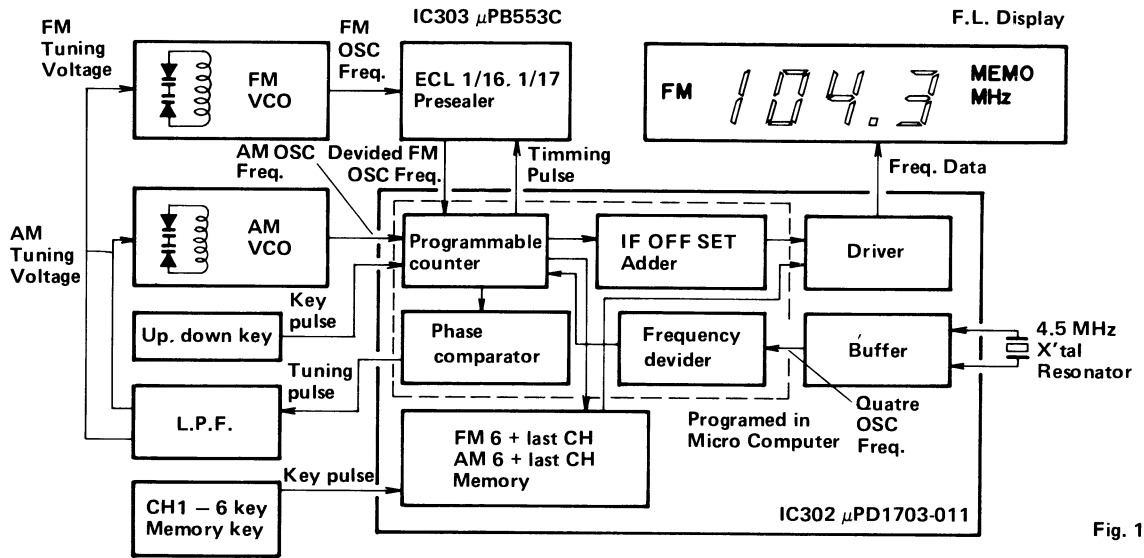

Fig. 10

7. Pin-plug to Pin-jack Connections Diagram

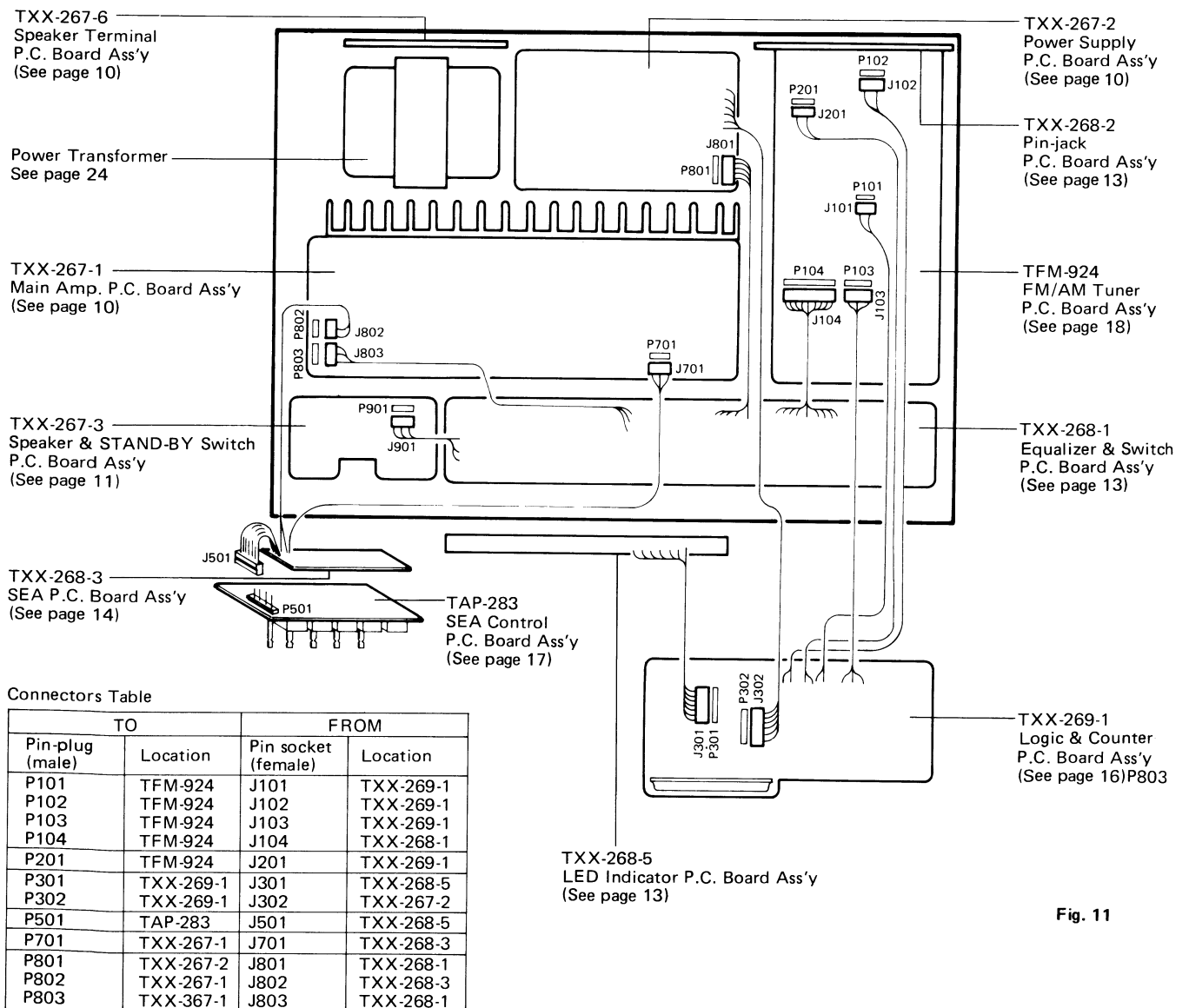
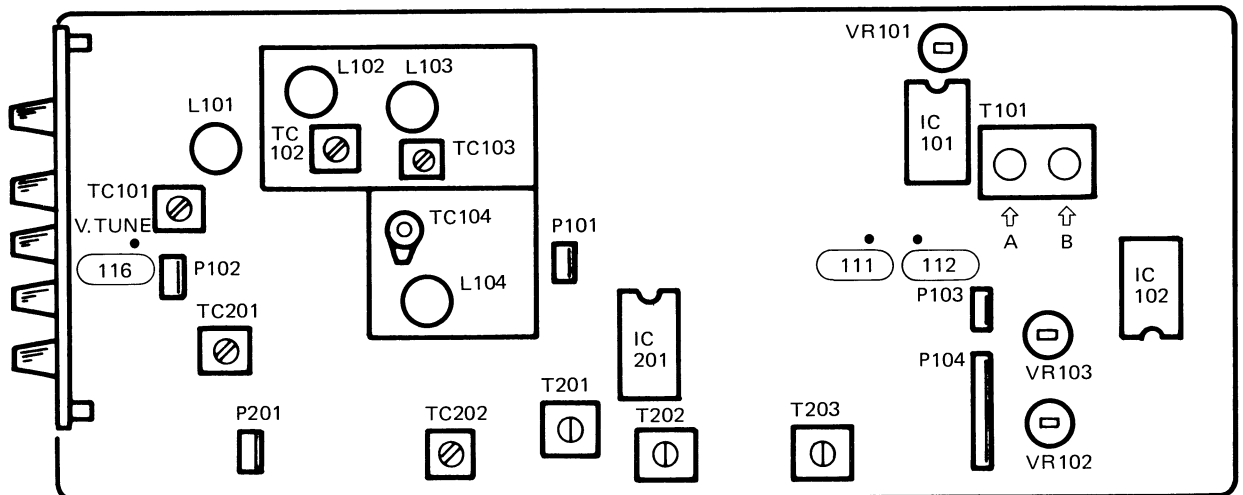

Fig. 11

Connectors Table

TO		FROM	
Pin-plug (male)	Location	Pin socket (female)	Location
P101	TFM-924	J101	TXX-269-1
P102	TFM-924	J102	TXX-269-1
P103	TFM-924	J103	TXX-269-1
P104	TFM-924	J104	TXX-268-1
P201	TFM-924	J201	TXX-269-1
P301	TXX-269-1	J301	TXX-268-5
P302	TXX-269-1	J302	TXX-267-2
P501	TAP-283	J501	TXX-268-5
P701	TXX-267-1	J701	TXX-268-3
P801	TXX-267-2	J801	TXX-268-1
P802	TXX-267-1	J802	TXX-268-3
P803	TXX-267-1	J803	TXX-268-1

8. FM/AM Tuner Alignment Procedures



Alignment Location of TFM-924 FM/AM Tuner P.C. Board Ass'y

Fig. 12

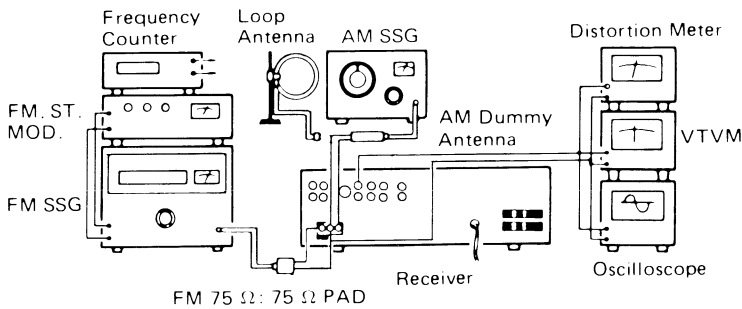

Fig. 13

Discriminator, Distortion and Signal Gain

1. Press to FM position.
2. Connect an RF generator, 1 kHz modulation and a 75 kHz deviation to the antenna terminals on the rear panel through a dummy antenna.
3. Connect an oscilloscope, Distortion Meter and VTVM to the Rec. out jacks on the rear panel.
4. Set the RF generator to 97.9 MHz.
5. Set the Frequency Display to a 97.9 MHz.
6. Connect a DC VTVM between TP111 and 112.
7. Adjust the core indicated arrow A of T101 for DC VTVM reading of 0 (zero) mV.
8. Adjust the core indicated arrow B of T101 so that the distortion is minimized at a value less than 0.4 %.

8-(1) FM Section

Sensitivity

Low Frequency

1. Connect an RF generator to the antenna terminals on the rear panel through a dummy antenna.
2. Set an RF generator to 90 MHz, a modulation of 1 kHz and a deviation of 75 kHz to provide an input of $2 \mu\text{V}$.
3. Connect a VTVM and an oscilloscope to the Rec. out jacks on the rear panel.
4. Set the frequency display to 89.9 MHz.
5. Adjust L104 so that "V. TUNE" TP116 indicate 3.7 V by VTVM.
6. Adjust three coils L101, L102 and L103 in the tuning gang to maximize the output.

High Frequency

7. Set the RF generator to 106 MHz, a modulation of 1 kHz and a deviation of 75 kHz to provide an input of $2 \mu\text{V}$.
8. Set the Frequency Display to 105.9 MHz.
9. Adjust TC104 so that "V. TUNE" TP116 indicate 18.0 V by VTVM.
10. Adjust the FM trimmers TC101, TC102 and TC103 in the tuning gang to maximize the output.
11. Repeat these high and low frequencies adjustment alternately until maximum sensitivity is obtained.

Multiplex and Stereo Separation

Multiplex

1. Set the stereo signal generator as follows: 400 Hz modulation frequency, 7.5 kHz deviation pilot, 67.5 kHz main and sub carriers. Connect its output to the RF generator.
2. Connect an RF generator to the antenna terminals through a dummy antenna.
3. Connect a VTVM, an oscilloscope and a distortion meter to the Rec. out jacks on the rear panel.
4. Set the RF generator to 97.9 MHz and output of 1 mV.
5. Set the frequency display to 97.9 MHz.
6. Connect the frequency counter to 19 kHz Test Point (TP110).
7. Switch off the pilot signal of stereo modulator.
8. Adjust VR103 so that the frequency counter indicates 19 kHz ($0 \sim -50$ Hz).

Stereo Separation

9. Switch the selector of stereo modulator to left channel modulation.
10. Adjust VR102 so that the output of right channel is minimized.
11. Switch the selector of the modulator to right channel modulation.
12. Adjust VR102 so that the left channel is minimized.
13. Set VR102 to a average, if the separation of left and right is different.

Muting Level

Note: No adjustment is necessary. However, if the check-up is required, take the following steps.

1. Release the MONO/FM MUTE OFF pushbutton during this adjustment procedures.
2. Connect a VTVM and an Oscilloscope to the Rec. out jacks on the rear panel.
3. Set the RF generator to 108 MHz, a modulation of 1 kHz and a deviation of 75 kHz, to provide an input of $8 \mu\text{V}$.
4. Turn VR101 clockwise and remember the point (or position) at which the muting ceases operating.
5. Turn VR101 counterclockwise slightly so that the output level drops by 1 dB.
6. Attenuate the output of the RF generator to 2 dB from $8 \mu\text{V}$ of step 2 and check that the muting is still operating.

8-(2) AM Section

Tracking and Sensitivity

Low Frequency

1. Press to AM position
2. Connect the RF generator to the antenna terminals on the rear panel, set this to 600 kHz (603 kHz) with 30 % modulation at 400 Hz.
3. Connect an AC VTVM and an Oscilloscope to the Rec. Out jacks on the rear panel.
4. Set the frequency display of the unit to 600 kHz (603 kHz).
5. Adjust T201, T202, T203 and the ferrite bar antenna adjusting the coil to maximize the output signal.

High Frequency

6. Set the RF generator to 1400 kHz (1404 kHz) with 30 % modulation at 400 Hz.
7. Set the frequency display of the unit to 1400 kHz (1404 kHz).
8. Adjust the trimmers TC201, TC202 in the tuning gang so that the output signal is maximized.
9. Repeat these high and low frequencies adjustment procedures alternately until maximum sensitivity is obtained.

9. Power Amplifier Idling Current Adjustment Procedure

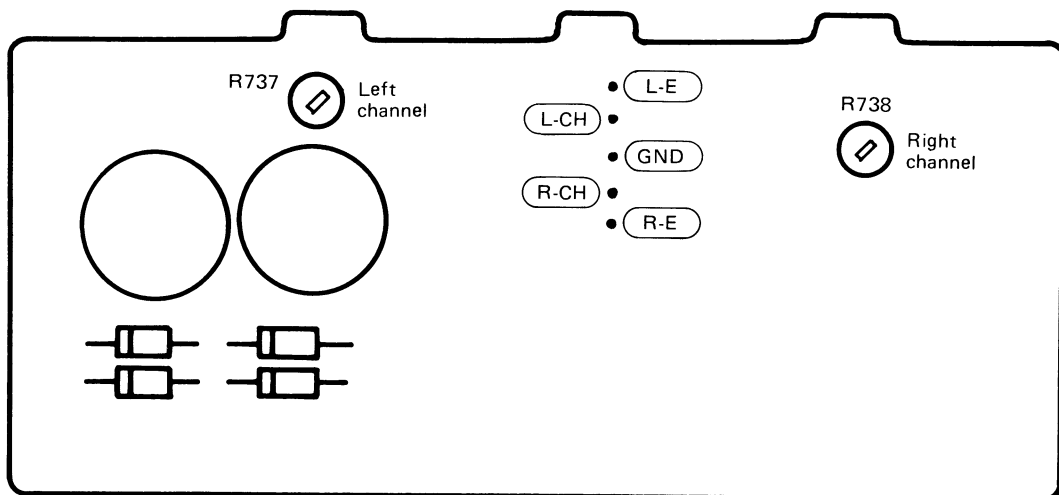

Adjustment Location of TXX-267 □-1 Main Amp. P.C. Board Ass'y

Fig. 14

Precaution:

- (1) Allow the set to warm up at least 5 minutes before connecting a DC VTVM.
- (2) Must keep the heatsinks cooling to prevent overheating and consequent destruction of the semiconductor junction and set the volume control to minimum during these adjustment procedures.

Procedures:

1. Turn R737 and (R738) fully counterclockwise before the power switch on.
2. Connect a DC VTVM to the Test Point L-CH and L-E (R-CH and R-E).
3. Adjust R737 (R738) for DC VTVM reading of 5 mV.

() : for Right channel Adjustment

10. Printed Circuit Board Ass'y and Parts List

10-(1) TXX-267 Main Amp., Power Supply and Other Functions Split P.C.Board Ass'y

The number of TXX-267 P.C. Board Ass'y varies according to the area employed. Refer to page 24.

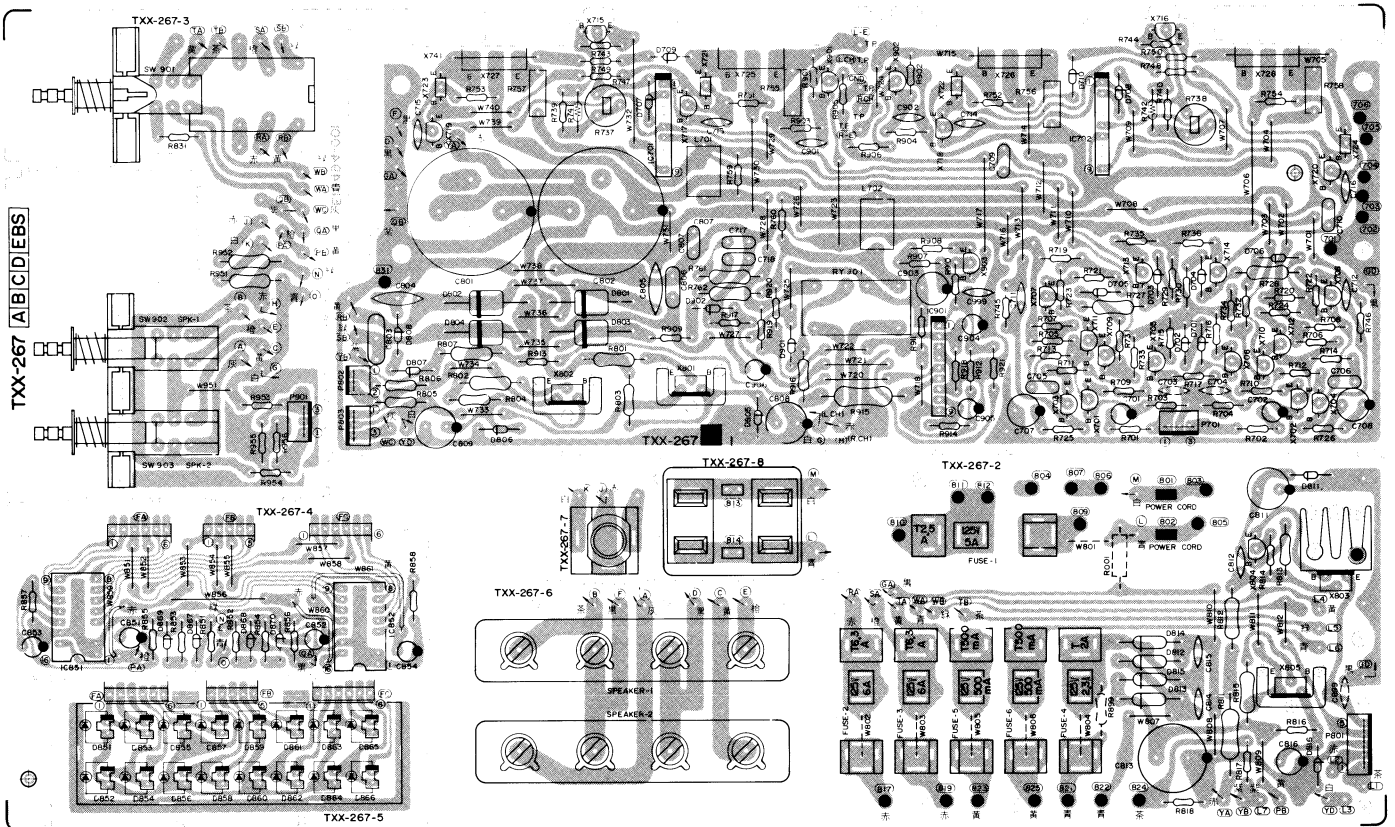

Fig. 15

Each Individual P.C. Board Location

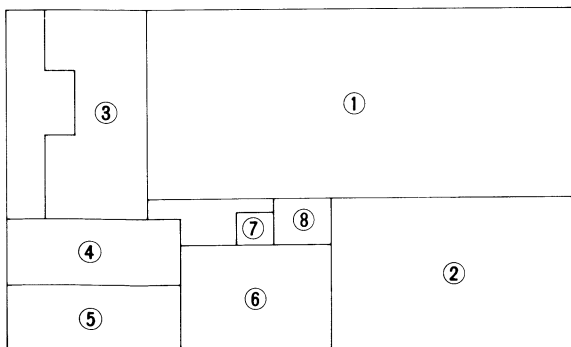

Fig. 16

- ① TXX-267 -1: Main Amp. P.C. Board Ass'y
- ② TXX-267 -2: Power Supply P.C. Board Ass'y
- ③ TXX-267-3 : Speaker STANDBY Switch P.C. Board Ass'y
- ④ TXX-267-4 : Power Indicator Driver P.C. Board Ass'y
- ⑤ TXX-267-5 : Power Indicator LED P.C. Board Ass'y
- ⑥ TXX-267-6 : Speaker Terminal P.C. Board Ass'y
- ⑦ TXX-267-7 : Headphones P.C. Board Ass'y
- ⑧ TXX-267 -8: AC Fuse & Outlet P.C. Board Ass'y

Note (2):

In should be indicated an area code according to the table below before placing an order.

Areas	P.C. Board
U.S.A.	TXX-267 <input type="checkbox"/> A -1, -2, -8
Canada	TXX-267 <input type="checkbox"/> B -1, -2, -8
U.K.	TXX-267 <input type="checkbox"/> EBS -1, -2, -8
Australia & Europe	TXX-267 <input type="checkbox"/> D -1, -2, -8
U.S. Military Market & Other Countries	TXX-267 <input type="checkbox"/> C -1, -2, -8

Note (1):

The specific symbols (赤, 黒, 白, ... etc.) on a surface of above P.C. Board are actually unrelated to the repair service and are significant denotement in order to process the proper assembly of P.C. Board at the factory.

Transistors

Item No.	Part Number	Rating		Description	
		Pc	fT	Silicon	Maker
X701	2SC1775AV(F1)	0.2 W	200 MHz	Silicon	Hitachi
X702	2SC1775AV(F1)	"	"	"	"
X703	2SC1775AV(F1)	"	"	"	"
X704	2SC1775AV(F1)	"	"	"	"
X705	2SC1775AV(F)	"	"	"	"

Transistors

Item No.	Part Number	Rating		Description	
		Pc	fT	Silicon	Maker
X706	2SC1775AV(F)	0.2 W	200 MHz	Silicon	Hitachi
X707	2SA949(O,Y)	3 W	120 MHz	"	Toshiba
X708	2SA949(O,Y)	"	"	"	"
X709	2SA949(O,Y)	"	"	"	"
X710	2SA949(O,Y)	"	"	"	"

Transistors

Item No.	Part Number	Rating		Description	
		Pc	fT		Maker
X711	2SA1029(C)	0.2 W	200 MHz	Silicon	Hitachi
X712	2SA1029(C)	"	"	"	"
X713	2SC2229(O,Y)	0.8 W	120 MHz	"	Toshiba
X714	2SC2229(O,Y)	"	"	"	"
X715	2SC2546(E)	0.4 W	90 MHz	"	Hitachi
X716	2SC2546(E)	"	"	"	"
X717	2SC1775AV(F)	0.2 W	200 MHz	"	"
X718	2SC1775AV(F)	"	"	"	"
X719	2SA872AV(E)	0.3 W	120 MHz	"	"
X720	2SA872AV(E)	"	"	"	"
X721	2SD669A(B,C)	20 W	140 MHz	"	"
X722	2SD669A(B,C)	"	"	"	"
X723	2SB649A(B,C)	"	"	"	"
X724	2SB649A(B,C)	"	"	"	"
X725	2SD845LB(R,O)	120 W	20 MHz	"	Toshiba
X726	2SD845LB(R,O)	"	"	"	"
X727	2SB755LB(R,O)	"	"	"	"
X728	2SB755LB(R,O)	"	"	"	"
X801	2SD313V(D,E)	30 W	8 MHz	"	Sanyo
X802	2SB507V(D,E)	"	"	"	"
X803	2SD313V(D,E)	"	"	"	"
X804	2SC1775AV(F)	0.2 W	200 MHz	"	Hitachi
X805	2SD313V(D,E)	30 W	8 MHz	"	Sanyo
X901	2SC1775AV(F)	0.2 W	200 MHz	"	Hitachi
X902	2SC1775AV(F)	"	"	"	"
X903	2SA872AV(F)	0.3 W	120 MHz	"	"

Integrated Circuits

Item No.	Part Number	Rating		Description	
		Pc			Maker
IC701	VC5022	0.5 W		I.C.	Toyo Dengu
IC702	VC5022			"	"
IC851	BA684			"	"
IC852	BA684			"	"
IC901	TA 7317P			"	Toshiba

Diodes

Item No.	Part Number	Rating	Description	
				Maker
D701	1S2076-31		Silicon	Hitachi
D702	1S2076-31		"	"
D703	1S2076-31		"	"
D704	1S2076-31		"	"
D705	1S2076-31		"	"
D706	1S2076-31		"	"
D707	1S2076-31		"	"
D708	1S2076-31		"	"
D709	1S2076-31		"	"
D710	1S2076-31		"	"
D801	30D2FA-S		"	Nihon Inter.
D802	30D2FA-S		"	"
D803	30D2FA-S		"	"
D804	30D2FA-S		"	"
D805	RD30EB3		Silicon (Zener)	NEC
D806	RD30EB3		"	"
D807	RD15EB3		"	"
D808	RD15EB3		"	"
D811	RD13EB3		"	"
D812	ERB12-02RK1		Silicon	Fuji
D813	ERB12-02RK1		"	"
D814	ERB12-02RK1		"	"
D815	ERB12-02RK1		"	"
D816	RD6, 2EB3		Silicon (Zener)	NEC
D851	SLB-26GG		LED	Toyo Dengu
D852	SLB-26GG		"	"
D853	SLB-26GG		"	"
D854	SLB-26GG		"	"

Diodes

Item No.	Part Number	Rating	Description	
				Maker
D855	SLB-26GG		LED	Toyo Dengu
D856	SLB-26GG		"	"
D857	SLB-26GG		"	"
D858	SLB-26GG		"	"
D859	SLB-26GG		"	"
D860	SLB-26GG		"	"
D861	SLB-26GG		"	"
D862	SLB-26GG		"	"
D863	SLB-26GG		"	"
D864	SLB-26GG		"	"
D865	SLB-26GG		"	"
D866	SLB-26GG		"	"
D867	1S2076-31		Silicon	Hitachi
D868	1S2076-31		"	"
D869	1S2076-31		"	"
D870	1S2076-31		"	"
D901	1S2076-31		"	"
D902	1S2076-31		"	"

Coils

Item No.	Part Number	Rating	Description
L701	E04059-1R0		Choke Coil
L702	E04059-1R0		"

Capacitors

Item No.	Part Number	Rating		Description
C701	QET61HR-475Z	4.7 μF	50 V	Electrolytic
C702	QET61HR-475Z	"	"	"
C705	QFM31HK-392Z	3900 pF	"	Mylar
C707	QET61CR-107Z	100 μF	16 V	Electrolytic
C708	QET61CR-107Z	"	"	"
C709	QFM31HK-272Z	2700 pF	50 V	Mylar
C710	QFM31HK-272Z	"	"	"
C711	QCS31HJ-120Z	12 pF	"	Ceramic
C712	QCS31HJ-120Z	"	"	"
C713	QCS22HJ-470	47 pF	500 V	"
C714	QCS22HJ-470	"	"	"
C715	QCS22HJ-470	"	"	"
C716	QCS22HJ-470	"	"	"
C717	QFM31HK-473Z	0.047 μF	50 V	Mylar
C718	QFM31HK-473Z	"	"	"
C801	QEZ0060-878E	8700 μF	56 V	Electrolytic
C802	QEZ0060-878E	"	"	"
C803	QFM32AK-104	0.1 μF	100 V	Mylar
C804	QCE22HP-103	0.01 μF	500 V	"
C805	QCE22HP-103	"	"	"
C806	QFM32AK-473	0.047 μF	100 V	Mylar
C807	QFM32AK-473	"	"	"
C808	QET51VR-227	220 μF	35 V	Electrolytic
C809	QET51VR-227	"	"	"
C811	QET51CR-227	"	16 V	"
C812	QCF31HP-103Z	0.01 μF	50 V	Ceramic
C813	QET51CR-228	2200 μF	16 V	Electrolytic
C814	QCF31HP-223Z	0.022 μF	50 V	Ceramic
C815	QCF31HP-223Z	"	"	"
C816	QET61AR-227Z	220 μF	10 V	Electrolytic
C851	QET61ER-106Z	10 μF	25 V	"
C852	QET61ER-106Z	"	"	"
C853	QET61HR-225Z	2.2 μF	50 V	"
C854	QET61HR-225Z	"	"	"
C901	QCF31HP-223Z	0.022 μF	"	Ceramic
C902	QCF31HP-223Z	"	"	"
C903	QET61HR-226Z	22 μF	"	Electrolytic
C904	QET61AR-107Z	100 μF	10 V	"
C905	QET61CR-226Z	22 μF	16 V	"
C906	QET61HR-105Z	1 μF	50 V	"
C999	QCF31HP-102Z	1000 pF	"	Ceramic

Resistors

Item No.	Part Number	Rating		Description
R001	QRC121K-275EM	2.7 MΩ	1/2 W	Composition △
R701	QRD141J-222SY	2.2 kΩ	1/4 W	Carbon
R702	QRD141J-222SY	"	"	"
R703	QRD141J-473SY	47 kΩ	"	"
R704	QRD141J-473SY	"	"	"
R705	QRD149J-102S	1 kΩ	"	Carbon △
R706	QRD149J-102S	"	"	" △
R707	QRD149J-102S	"	"	" △
R708	QRD149J-102S	"	"	" △
R709	QRD149J-220S	22 Ω	"	" △
R710	QRD149J-220S	"	"	" △
R711	QRD149J-220S	"	"	" △
R712	QRD149J-220S	"	"	" △
R713	QRD149J-150S	15 Ω	"	" △
R714	QRD149J-150S	"	"	" △
R715	QRD149J-301S	300 Ω	"	" △
R716	QRD149J-301S	"	"	" △
R717	QRD141J-223SY	22 kΩ	"	Carbon
R719	QRD149J-220S	22 Ω	"	Carbon △
R720	QRD149J-220S	"	"	" △
R721	QRD149J-100S	10 Ω	"	" △
R722	QRD149J-100S	"	"	" △
R723	QRD149J-100S	"	"	" △
R724	QRD149J-100S	"	"	" △
R725	QRD141J-132SY	1.3 kΩ	"	Carbon
R726	QRD141J-132SY	"	"	" △
R727	QRG017J-822S	8.2 kΩ	1 W	Oxide Metal Film △
R728	QRG017J-822S	"	"	" △
R729	QRD149J-181S	180 Ω	1/4 W	Carbon △
R730	QRD149J-181S	"	"	" △
R731	QRD149J-561S	560 Ω	"	" △
R732	QRD149J-561S	"	"	" △
R733	QRD129J-473	47 kΩ	1/2 W	Carbon △
R734	QRD141J-473SY	"	1/4 W	Carbon
R735	QRD149J-181S	180 Ω	"	Carbon △
R736	QRD149J-181S	"	"	" △
R737	QVZ3501-471	470 Ω	"	Variable
R738	QVZ3501-471	"	"	"
R739	QRD141J-471SY	"	1/4 W	Carbon
R740	QRD141J-471SY	"	"	"
R741	SDT35	350 Ω	1 W	Thermistor
R742	SDT35	"	"	"
R743	QRD141J-391SY	390 Ω	1/4 W	Carbon
R744	QRD141J-391SY	"	"	"
R745	QRD141J-243SY	24 kΩ	"	"
R746	QRD141J-243SY	"	"	"
R747	QRD149J-122S	1.2 kΩ	"	Carbon △
R748	QRD149J-122S	"	"	" △
R749	QRD149J-101S	100 Ω	"	" △
R750	QRD149J-101S	"	"	" △
R751	QRD149J-100S	10 Ω	"	" △
R752	QRD149J-100S	"	"	" △
R753	QRD149J-100S	"	"	" △
R754	QRD149J-100S	"	"	" △
R755	QRM054K-R22	0.22 Ω	5 W	Metal Plate △
R756	QRM054K-R22	"	"	" △
R757	QRM054K-R22	"	"	" △
R758	QRM054K-R22	"	"	" △
R759	QRD149J-4R7S	4.7 Ω	1/4 W	Carbon △
R760	QRD149J-4R7S	"	"	" △
R761	See page 24	10 Ω	1 W	Oxide Metal Film △
R762	See page 24	"	"	" △
R801	QRG017J-680S	68 Ω	"	" △
R802	QRG017J-680S	"	"	" △
R803	QRD129J-472	4.7 kΩ	1/2 W	Carbon △

Resistors

Item No.	Part Number	Rating		Description
R804	QRD129J-472	4.7 kΩ	1/2 W	Carbon △
R805	QRD129J-151	150 Ω	"	" △
R806	QRD129J-151	"	"	" △
R807	QRG017J-152S	1.5 kΩ	1 W	Oxide Metal Film △
R811	QRG027J-680	68 Ω	2 W	" △
R812	QRG017J-330S	33 Ω	1 W	" △
R813	QRD129J-392	3.9 kΩ	1/2 W	Carbon △
R814	QRD149J-101S	100 Ω	1/4 W	" △
R815	QRD129J-6R8	6.8 Ω	1/2 W	" △
R816	QRD149J-102S	1 kΩ	1/4 W	" △
R817	QRD141J-821SY	820 Ω	"	Carbon
R818	QRD141J-682SY	6.8 kΩ	"	"
R831	QRD141J-471SY	470 Ω	"	"
R852	QRD141J-332SY	3.3 kΩ	"	"
R853	QRD141J-390SY	39 Ω	"	"
R854	QRD141J-390SY	"	"	"
R855	QRD141J-103SY	10 kΩ	"	"
R856	QRD141J-103SY	"	"	"
R857	QRD141J-473SY	47 kΩ	"	"
R858	QRD141J-473SY	"	"	"
R899	See page 24	2.7 Ω	1/2 W	"
R901	QRD141J-222SY	2.2 kΩ	1/4 W	"
R902	QRD141J-222SY	"	"	"
R903	QRD141J-102SY	1 kΩ	"	"
R904	QRD141J-102SY	"	"	"
R905	QRD141J-123SY	12 kΩ	"	"
R906	QRD141J-123SY	"	"	"
R907	QRD141J-103SY	10 kΩ	"	"
R908	QRD141J-332SY	3.3 kΩ	"	"
R909	QRD141J-683SY	68 kΩ	"	"
R910	QRD141J-563SY	56 kΩ	"	"
R911	QRD141J-183SY	18 kΩ	"	"
R912	QRD141J-683SY	68 kΩ	"	"
R913	QRD141J-153SY	15 kΩ	"	"
R914	QRD141J-204SY	200 kΩ	"	"
R915	QRG027J-681	680 Ω	2 W	Oxide Metal Film △
R916	QRD129J-271	270 Ω	1/2 W	Carbon △
R917	QRD141J-223SY	22 kΩ	1/4 W	Carbon
R918	QRD141J-104SY	100 kΩ	"	"
R919	QRD141J-104SY	"	"	"
R920	QRD141J-104SY	"	"	"
R921	QRD141J-563SY	56 kΩ	"	"
R951	QRG017J-221S	220 Ω	1 W	Oxide Metal Film △
R952	QRG017J-221S	"	"	" △
R953	QRD141J-332SY	3.3 kΩ	1/4 W	Carbon
R954	QRD141J-332SY	"	"	"
R955	QRD141J-681SY	680 Ω	"	"
R956	QRD141J-681SY	"	"	"

Others

Item No.	Part Number	Rating	Description
J901	QMC0437-001		AC Outlet △
P701	QMS6302-102		Headphones Jack
P801	QMV5005-003		3-pins Plug Ass'y
P802	QMV5005-005		5-pins Plug Ass'y
P802	QMV5005-002		2-pins Plug Ass'y
P803	QMV5005-003		3-pins Plug Ass'y
P901	QMV5005-003		"
	E67275-001		L-Bracket
SW901	QSP0020-001E		Push Switch
RY901	ESK6D24-213		Relay Switch
	E03572-007EM		Speaker Terminal
	E300932-001		LED Holder
	E300934-001		Heat-sink
	E60171-003		"
SW902, 903	QSP0229-019		Push Switch

10-(2) TXX-268 Equalizer, S.E.A. and Other Functions Split P.C.Board Ass'y

The number of TXX-268 □ P.C. Board Ass'y varies according to the area employed.

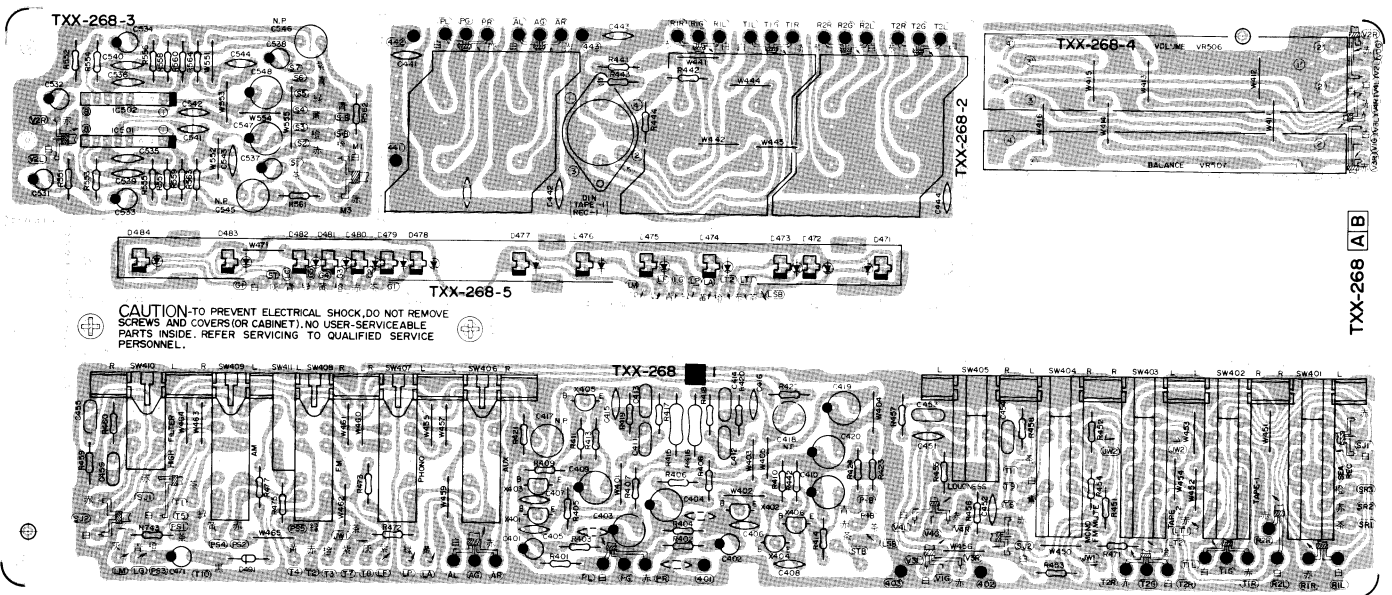

Fig. 17

Each Individual P.C. Board Location

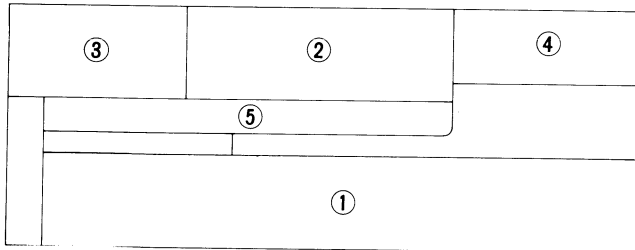

Fig. 18

Note (1):

The specific symbols (赤, 黒, 白, ... etc.) on a surface of above P.C. Board are actually unrelated to the repair service and are significant denotement in order to process the proper assembly of P.C. Board at the factory.

- ① TXX-268-1 : Equalizer and Switch P.C. Board Ass'y
- ② TXX-268 □-2: Pin-jack P.C. Board Ass'y
- ③ TXX-268-3 : S.E.A. (Sound Effect Amp.) P.C. Board Ass'y
- ④ TXX-268-4 : Balance Control P.C. Board Ass'y
- ⑤ TXX-268-5 : LED Indicator P.C. Board Ass'y

Note (2):

In □ should be indicated an area code according to table below before placing an order.

Areas	P.C. Board Ass'y
U.S.A., Canada, U.S. Military Market and Other Countries	TXX-268 [A] -2
U.K., Australia and Europe	TXX-268 [B] -2

Transistors

Item No.	Part Number	Rating		Description	
		Pc	fT		Maker
X401	2SA872AV(E)	0.3 W	120 MHz	Silicon	Hitachi
X402	2SA872AV(E)	"	"	"	"
X403	2SC1775AV(F)	0.2 W	200 MHz	"	"
X404	2SC1775AV(F)	"	"	"	"
X405	2SD438(D,E)	0.75 W	100 MHz	"	Sanyo
X406	2SD438(D,E)	"	"	"	"

Integrated Circuits

Item No.	Part Number	Rating		Description	
		Pc			Maker
IC501	HA 1457	0.5 W	"	IC	Hitachi
IC502	HA 1457				

Diodes

Item No.	Part Number	Rating	Description	
				Maker
D471	SLB-26UR		LED	Toyodengu
D472	SLB-26GG		"	"
D473	SLB-26GG		"	"
D474	SLB-26UR		"	"
D475	SLB-26UR		"	"
D476	SLB-26UR		"	"
D477	SLB-26UR		"	"
D478	SLB-26UR		"	"
D479	SLB-26UR		"	"
D480	SLB-26UR		"	"
D481	SLB-26UR		"	"
D482	SLB-26UR		"	"
D483	SLB-26GG		"	"
D484	SLB-26UR	Silicon	Hitachi	
D491	1S2076-31			
D499	1S2076-31			

Capacitors

Item No.	Part Number	Rating		Description
C401	QET61HR-475Z	4.7 μ F	50 V	Electrolytic
C402	QET61HR-475Z	"	"	"
C403	QET60JR-227Z	220 μ F	6.3 V	"
C404	QET60JR-227Z	"	"	"
C405	QCS31HJ-101Z	100 pF	50 V	Ceramic
C406	QCS31HJ-101Z	"	"	"
C407	QCS31HJ-470Z	47 pF	"	"
C408	QCS31HJ-470Z	"	"	"
C409	QET60JR-227Z	220 μ F	6.3 V	Electrolytic
C410	QET60JR-227Z	"	"	"
C411	QFM31HK-153Z	0.015 μ F	50 V	Mylar
C412	QFM31HK-153Z	"	"	"
C413	QFM31HK-472Z	4700 pF	"	"
C414	QFM31HK-472Z	"	"	"
C415	QCS31HJ-471Z	470 pF	"	Ceramic
C416	QCS31HJ-471Z	"	"	"
C417	QEZ0046-105	1 μ F	"	Electrolytic
C418	QEZ0046-105	"	"	"
C419	QET61HR-476Z	47 μ F	"	"
C420	QET61HR-476Z	"	"	"
C441	QCF31HP-223Z	0.022 μ F	"	Ceramic
C442	QCF31HP-103Z	0.01 μ F	"	"
C443	QCF31HP-103Z	"	"	"
C444	QCF31HP-103Z	"	"	"
C451	QCS31HJ-271Z	270 pF	"	"
C452	QCS31HJ-271Z	"	"	"
C453	QFM31HK-273	0.027 μ F	"	Mylar
C454	QFM31HK-273	"	"	"
C455	QFM31HK-822	0.0082 μ F	"	"
C456	QFM31HK-822	"	"	"
—	—	—	—	—
C531	QET61HR-475Z	4.7 μ F	50 V	"
C532	QET61HR-475Z	"	"	"
C533	QET61AR-476Z	47 μ F	10 V	"
C534	QET61AR-476Z	"	"	"
C535	QCS31HJ-101Z	100 pF	50 V	Ceramic
C536	QCS31HJ-101Z	"	"	"
C537	QET61AR-476Z	47 μ F	10 V	Electrolytic
C538	QET61AR-476Z	"	"	"
C539	QCS31HJ-820Z	82 pF	50 V	Ceramic
C540	QCS31HJ-820Z	"	"	"
C541	QCS31HJ-560Z	56 pF	"	"
C542	QCS31HJ-560Z	"	"	"
C543	QCS31HJ-271Z	270 pF	"	"
C544	QCS31HJ-271Z	"	"	"
C545	QEZ0046-475	4.7 μ F	"	Electrolytic
C546	QEZ0046-475	"	"	"
C547	QET61ER-476Z	47 μ F	25 V	"
C548	QET61ER-476Z	"	"	"

Resistors

Item No.	Part Number	Rating		Description
R413	QRD141J-331SY	330 Ω	1/4 W	Carbon
R414	QRD141J-331SY	"	"	"
R415	QRG017J-222S	2.2 k Ω	1 W	Oxide Metal Film
R416	QRG017J-222S	"	"	"
R417	QRD141J-224SY	220 k Ω	1/4 W	Carbon
R418	QRD141J-224SY	"	"	"
R419	QRD141J-153SY	15 k Ω	"	"
R420	QRD141J-153SY	"	"	"
R421	QRD141J-224SY	220 k Ω	"	"
R422	QRD141J-224SY	"	"	"
R423	QRD149J-560S	56 Ω	"	"
R424	QRD149J-560S	"	"	"
R441	QRD141J-334SY	330 k Ω	"	"
R442	QRD141J-334SY	"	"	"
R443	QRD141J-104SY	100 k Ω	"	"
R444	QRD141J-104SY	"	"	"
R451	QRD141J-332SY	3.3 k Ω	"	"
R452	QRD141J-332SY	"	"	"
R453	QRD141J-332SY	"	"	"
R454	QRD141J-332SY	"	"	"
R455	QRD141J-564SY	560 k Ω	"	"
R456	QRD141J-564SY	"	"	"
R457	QRD141J-223SY	22 k Ω	"	"
R458	QRD141J-223SY	"	"	"
R459	QRD141J-564SY	560 k Ω	"	"
R460	QRD141J-564SY	"	"	"
R471	QRD141J-681SY	680 Ω	"	"
R472	QRD141J-102SY	1 k Ω	"	"
R473	QRD141J-102SY	"	"	"
R474	QRD141J-102SY	"	"	"
R475	QRD141J-221SY	220 Ω	"	"
—	—	—	—	—
—	—	—	—	—
R506	QVT9C2B-5G5E	150 k(B)		Variable
R507	QVT6C2W-6F5	250 k(W)		
R551	QRD141J-184SY	180 k Ω	1/4 W	Carbon
R552	QRD141J-184SY	"	"	"
R553	QRD141J-102SY	1 k Ω	"	"
R554	QRD141J-102SY	"	"	"
R555	QRD141J-222SY	2.2 k Ω	"	"
R556	QRD141J-222SY	"	"	"
R557	QRD141J-682SY	6.8 k Ω	"	"
R558	QRD141J-682SY	"	"	"
R559	QRD141J-103SY	10 k Ω	"	"
R560	QRD141J-103SY	"	"	"
R561	QRD141J-562SY	5.6 k Ω	"	"
R562	QRD141J-562SY	"	"	"
R563	QRD141J-102SY	1 k Ω	"	"
R564	QRD141J-102SY	"	"	"

Resistors

Item No.	Part Number	Rating		Description
R401	QRD141J-222SY	2.2 k Ω	1/4 W	Carbon
R402	QRD141J-222SY	"	"	"
R403	QRD141J-563SY	56 k Ω	"	"
R404	QRD141J-563SY	"	"	"
R405	QRD141J-271SY	270 Ω	"	"
R406	QRD141J-271SY	"	"	"
R407	QRD141J-224SY	220 k Ω	"	"
R408	QRD141J-224SY	"	"	"
R409	QRD141J-473SY	47 k Ω	"	"
R410	QRD141J-473SY	"	"	"
R411	QRD141J-392SY	3.9 k Ω	"	"
R412	QRD141J-392SY	"	"	"

Others

Item No.	Part Number	Rating	Description
TP104	EWS01B-001		11-pins Socket Ass'y
TP301	EWS018-013		8-pins Socket Ass'y
TP501	EWS017-016		7-pins Socket Ass'y
TP701	EWS013-046		3-pins Socket Ass'y
TP801	EWS015-024		5-pins Socket Ass'y
TP802	EWS012-031		2-pins Socket Ass'y
TP803	EWS013-036		3-pins Socket Ass'y
TP901	EWS013-037		"
	E03591-42D		4-pins Jack Ass'y
	E03623-003		DIN Socket (TXX-268B-2)
(S)	E300930-001		LED Holder

10-(3) TXX-269 Logic and Counter P.C.Board Ass'y

The number of TXX-269 P.C. Board Ass'y varies according to the area employed.

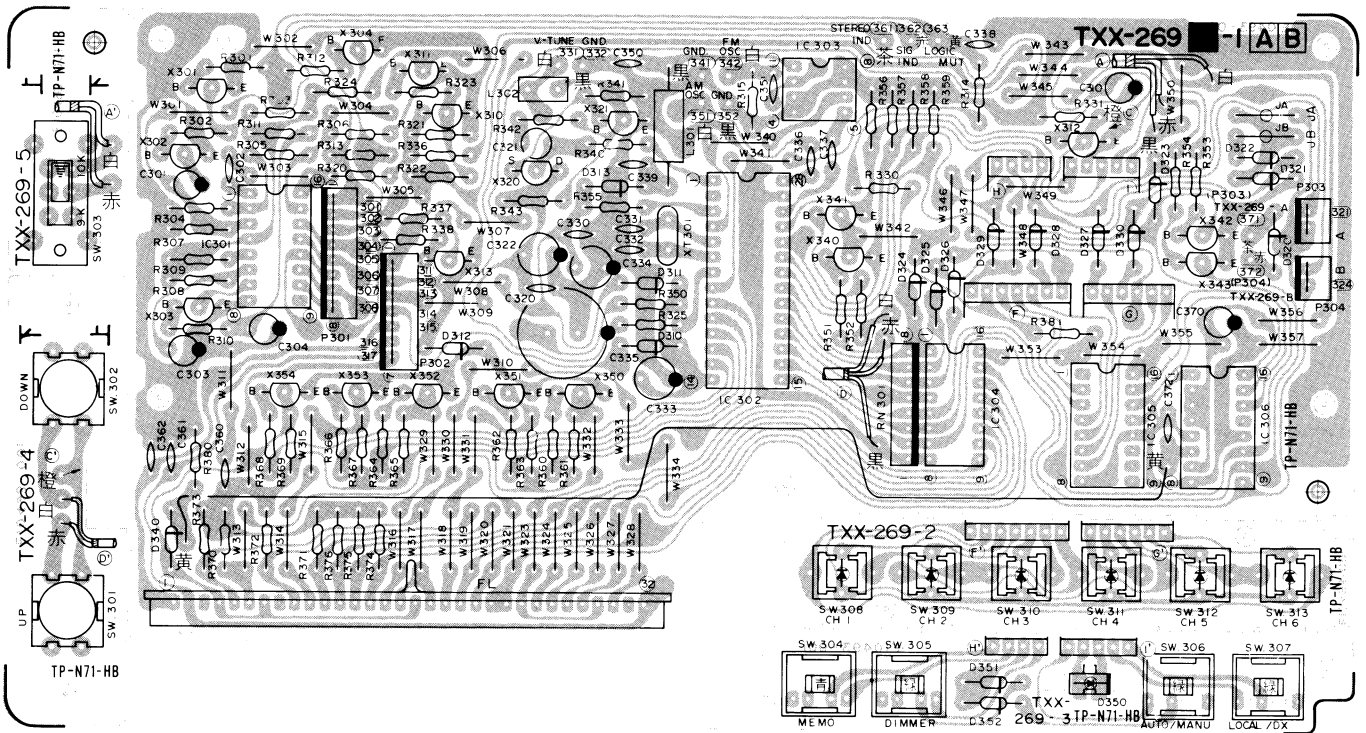

Fig. 19

Each Individual P.C. Board Location

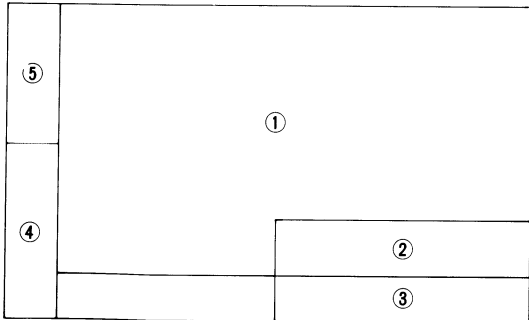

Fig. 20

Note (1):

The specific symbols (赤, 黒, 白, ... etc.) on a surface of above P.C. Board are actually unrelated to the repair service and are significant denotement in order to process the proper assembly of P.C. Board at the factory.

Transistors

Item No.	Part Number	Rating		Description	
		Pc	fT	Maker	Maker
X301	2SC458(C,D)	0.2 W	230 MHz	Silicon	Hitachi
X302	2SC458(C,D)	"	"	"	"
X303	2SC458(C,D)	"	"	"	"
X304	2SC458(C,D)	"	"	"	"
X310	2SC458(C,D)	"	"	"	"
X311	2SC458(C,D)	"	"	"	"
X312	2SA1029(C,D)	"	200 MHz	"	"
X313	2SA1029(C,D)	"	"	"	"
X320	2SK105(F)	0.25 W	"	F.E.T.	NEC
X321	2SC458(D)	0.2 W	230 MHz	Silicon	Hitachi
X340	2SC458(C,D)	"	"	"	"
X341	2SC458(C,D)	"	"	"	"
X342	2SC458(C)	"	"	"	"
X343	2SC458(C)	"	"	"	"
X350	2SA872AV(D,E)	0.3 W	120 MHz	"	"

- ① TXX-269 -1: Logic and Counter P.C. Board Ass'y
- ② TXX-269-2 : Preset/Station Select Switch P.C. Board Ass'y
- ③ TXX-269-3 : Memory Switch P.C. Board Ass'y
- ④ TXX-269-4 : Up/Down Switch P.C. Board Ass'y
- ⑤ TXX-269-5 : 9 kHz/10 kHz Select Switch P.C. Board Ass'y

Note (2):

In should be indicated an area code according to table below before placing an order.

Areas	P.C. Board Ass'y
U.S.A., Canada and U.S. Military Market	TXX-269 <input type="checkbox"/> A -1
U.K., Australia, Europe and Other Countries	TXX-269 <input type="checkbox"/> B -1

Transistors

Item No.	Part Number	Rating		Description	
		Pc	fT	Maker	Maker
X351	2SA872AV(D,E)	0.3 W	120 MHz	Silicon	Hitachi
X352	2SA872AV(D,E)	"	"	"	"
X353	2SA872AV(D,E)	"	"	"	"
X354	2SA872AV(D,E)	"	"	"	"

Integrated Circuits

Item No.	Part Number	Rating	Description
		Pc	
IC301	LB1405		IC Sanyo
IC302	UPD1703C-011		NEC
IC303	UPB553AC		"
IC304	TC5066BP		Toshiba
IC305	HD74LS42P		Hitachi
IC306	TC4035BP		Toshiba

Diodes

Item No.	Part Number	Rating	Description	
				Maker
D310	1S2076-31		Silicon	Hitachi
D311	1S2076-31		"	"
D312	1S2076-31		"	"
D313	1S2076-31		"	"
D320	1S2076-31		"	"
D321	1S2076-31		"	"
D322	1S2076-31		"	"
D323	1S2076-31		"	"
D324	1S2076-31		"	"
D325	1S2076-31		"	"
D326	1S2076-31		"	"
D327	1S2076-31		"	"
D328	1S2076-31		"	"
D329	1S2076-31		"	"
D330	1S2076-31		"	"
D340	1S2076-31		"	"
D350	SLB-26GG		LED	ToyoDengu
D351	1S2076-31		Silicon	Hitachi
D352	1S2076-31		"	"

Coils

Item No.	Part Number	Rating	Description
L301	E03695-001		Choke Coil
L302	E03522-391KY		"

Capacitors

Item No.	Part Number	Rating		Description
C301	QET61ER-106Z	10 μ F	25 V	Electrolytic
C302	QCS31HJ-470Z	47 pF	50 V	Ceramic
C303	QET61HR-105Z	1 μ F	"	Electrolytic
C304	QET61ER-106Z	10 μ F	25 V	"
C310	QET51CR-226	22 μ F	16 V	"
C320	QCF31HP-223Z	0.022 μ F	50 V	Ceramic
C321	QEZ0046-105	1 μ F	"	Electrolytic
C322	QET61HR-476Z	47 μ F	"	"
C330	QCF31HP-223Z	0.022 μ F	"	Ceramic
C331	QCS21HJ-220	22 pF	"	"
C332	QCS21HJ-220	"	"	"
C333	QET51CR-476	47 μ F	16 V	Electrolytic
C334	QET51CR-476	"	"	"
C335	QET50JR-228H	2200 μ F	6.3 V	"
C336	QCF31HP-102Z	1000 pF	50 V	Ceramic
C337	QCF31HP-102Z	"	"	"
C338	QCF31HP-223Z	0.022 μ F	"	"
C339	QCF21HP-223	"	"	"
C350	QCF31HP-223Z	"	"	"
C351	QCS31HJ-330Z	33 pF	"	"
C360	QET51VR-107	100 μ F	35 V	Electrolytic
C361	QFM31HK-223	0.022 pF	50 V	Mylar
C362	QFM31HK-223	"	"	"
C370	QET51ER-106	10 μ F	25 V	Electrolytic
C372	QCS21HJ-330	33 pF	50 V	Ceramic

Resistors

Item No.	Part Number	Rating		Description
R301	QRD141J-333SY	33 k Ω	1/4 W	Carbon
R302	QRD141J-333SY	"	"	"
R303	QRD141J-223SY	22 k Ω	"	"
R304	QRD141J-562SY	5.6 k Ω	"	"
R305	QRD141J-563SY	56 k Ω	"	"
R306	QRD141J183SY	18 k Ω	"	"

Resistors

Item No.	Part Number	Rating		Description
R307	QRD141J-153SY	15 k Ω	1/4 W	Carbon
R308	QRD141J-271SY	270 Ω	"	"
R309	QRD141J-153SY	15 k Ω	"	"
R310	QRD141J-104SY	100 k Ω	"	"
R311	QRD141J-224SY	220 k Ω	"	"
R312	QRD141J-473SY	47 k Ω	"	"
R313	QRD141J-222SY	2.2 k Ω	"	"
R314	QRD141J-103SY	10 k Ω	"	"
R315	QRD141J-470SY	47 Ω	"	"
R320	QRD141J-123SY	12 k Ω	"	"
R321	QRD141J-123SY	"	"	"
R322	QRD141J-273SY	27 k Ω	"	"
R323	QRD141J-223SY	22 k Ω	"	"
R324	QRD141J-473SY	47 k Ω	"	"
R325	QRD141J-103SY	10 k Ω	"	"
R330	QRD141J-103SY	"	"	"
R331	QRD141J-271SY	270 Ω	"	"
R336	QRD141J-332SY	3.3 k Ω	"	"
R337	QRD141J-271SY	270 Ω	"	"
R338	QRD141J-153SY	15 k Ω	"	"
R340	QRD141J-472SY	4.7 k Ω	"	"
R341	QRD141J-331SY	330 Ω	"	"
R342	QRD141J-332SY	3.3 k Ω	"	"
R343	QRD141J-682SY	6.8 k Ω	"	"
R350	QRD141J-102SY	1 k Ω	"	"
R351	QRD141J-105SY	1 M Ω	"	"
R352	QRD141J-105SY	"	"	"
R353	QRD141J-475SY	4.7 M Ω	"	"
R354	QRD141J-185SY	1.8 M Ω	"	"
R355	QRD141J-225SY	2.2 M Ω	"	"
R356	QRD141J-223SY	22 k Ω	"	"
R357	QRD141J-223SY	"	"	"
R358	QRD141J-223SY	"	"	"
R359	QRD141J-223SY	"	"	"
R360	QRD141J-123SY	12 k Ω	"	"
R361	QRD141J-104SY	100 k Ω	"	"
R362	QRD141J-123SY	12 k Ω	"	"
R363	QRD141J-104SY	100 k Ω	"	"
R364	QRD141J-123SY	12 k Ω	"	"
R365	QRD141J-104SY	100 k Ω	"	"
R366	QRD141J-123SY	12 k Ω	"	"
R367	QRD141J-104SY	100 k Ω	"	"
R368	QRD141J-123SY	12 k Ω	"	"
R369	QRD141J-104SY	100 k Ω	"	"
R370	QRD141J-154SY	150 k Ω	"	"
R371	QRD141J-154SY	"	"	"
R372	QRD141J-154SY	"	"	"
R373	QRD141J-154SY	"	"	"
R374	QRD141J-154SY	"	"	"
R375	QRD141J-154SY	"	"	"
R376	QRD141J-154SY	"	"	"
R380	QRD141J-104SY	100 k Ω	"	"
R381	QRD141J-331SY	330 Ω	"	"

Others

Item No.	Part Number	Rating	Description
P301	QMV5005-008		8-pins Plug Ass'y
P302	QMV5005-007		7-pins Plug Ass'y
P303	QMV5005-002		2-pins Plug Ass'y
P304	QMV5005-002		"
FL301	ELU0001-003		Fluorescent Display
RN301	ERGS7XK-473		Resistor Network
SW301	ESP0001-003		Tact Switch
SW302	ESP0001-003		"
SW303	QSS2201-002	AM Channel Spacing	Slide Switch (TXX-269A)
SW304	QSP0410-003		Push Switch

Others

Item No.	Part Number	Rating	Description
SW305	QSP0410-004		Push Switch
SW306	QSP0410-001		"
SW307	QSP0410-001		"
SW308	ESP0010-R01A		Test Switch with LED
SW309	ESP0010-R01A		"
SW310	ESP0010-R01A		"
SW311	ESP0010-R01A		"
SW312	ESP0010-R01A		"
SW313	ESP0010-R01A		"
D350			

Others

Item No.	Part Number	Rating	Description
TP101	EWS012-027		SKT Wire Ass'y
TP102	EWS012-028		"
TP103	EWS014-028		"
TP201	EWS012-029		"
XT301	E03737-010		X'tal (4.5 MHz)
	EWR34A-20NN		Flat Cable Ass'y
	EWR35A-20NN		"
	EWR36A-15NN		"
	EWR37A-15NN		"
	EWS012-030		Socket Wire Ass'y
	E67276-001		LED Holder

10-(4) TAP-283 S.E.A. Control P.C.Board Ass'y

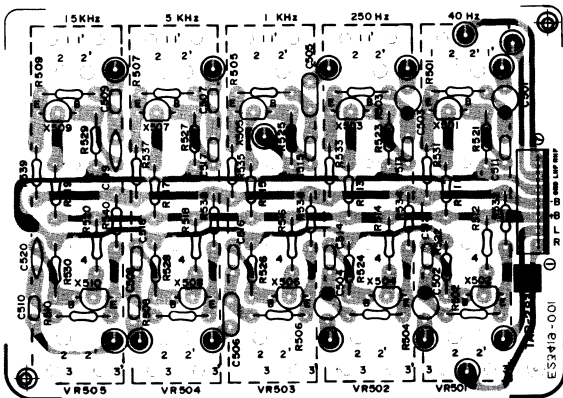

Fig. 21

Transistors

Item No.	Part Number	Rating		Description	
		Pc	fT	Material	Maker
X501	2SC1775AV(F)	0.2 W	200 MHz	Silicon	Hitachi
X502	2SC1775AV(F)	"	"	"	"
X503	2SC1775AV(F)	"	"	"	"
X504	2SC1775AV(F)	"	"	"	"
X505	2SC1775AV(F)	"	"	"	"
X506	2SC1775AV(F)	"	"	"	"
X507	2SC1775AV(F)	"	"	"	"
X508	2SC1775AV(F)	"	"	"	"
X509	2SC1775AV(F)	"	"	"	"
X510	2SC1775AV(F)	"	"	"	"

Capacitors

Item No.	Part Number	Rating		Description
		Value	Voltage	
C501	QET61HR-475Z	4.7 μF	50 V	Electrolytic
C502	QET61HR-475Z	"	"	"
C503	QET61HR-474Z	0.47 μF	"	"
C504	QET61HR-474Z	"	"	"
C505	QFM31HK-124Z	0.12 μF	"	Mylar
C506	QFM31HK-124Z	"	"	"
C507	QFM31HK-273Z	0.027 μF	"	"
C508	QFM31HK-273Z	"	"	"
C509	QFM31HK-562Z	5600 pF	"	"
C510	QFM31HK-562Z	"	"	"
C511	QFM31HK-223Z	0.022 μF	"	"
C512	QFM31HK-223Z	"	"	"
C513	QFM31HK-822Z	8200 pF	"	"
C514	QFM31HK-822Z	"	"	"
C515	QFM31HK-332Z	3300 pF	"	"
C516	QFM31HK-332Z	"	"	"
C517	QFM31HK-102Z	1000 pF	"	"
C518	QFM31HK-102Z	"	"	"
C519	QCS21HJ-681	680 pF	"	Ceramic
C520	QCS21HJ-681	"	"	"

Resistors

Item No.	Part Number	Rating		Description
		Value	Power	
R501	QRD141J-122SY	1.2 kΩ	1/4 W	Carbon
R502	QRD141J-122SY	"	"	"
R503	QRD141J-122SY	"	"	"
R504	QRD141J-122SY	"	"	"
R505	QRD141J-122SY	"	"	"
R506	QRD141J-122SY	"	"	"
R507	QRD141J-122SY	"	"	"
R508	QRD141J-122SY	"	"	"
R509	QRD141J-122SY	"	"	"
R510	QRD141J-122SY	"	"	"
R511	QRD141J-391SY	390 Ω	"	"
R512	QRD141J-391SY	"	"	"
R513	QRD141J-391SY	"	"	"
R514	QRD141J-391SY	"	"	"
R515	QRD141J-391SY	"	"	"
R516	QRD141J-391SY	"	"	"
R517	QRD141J-391SY	"	"	"
R518	QRD141J-391SY	"	"	"
R519	QRD141J-391SY	"	"	"
R520	QRD141J-391SY	"	"	"
R521	QRD141J-134SY	130 kΩ	"	"
R522	QRD141J-134SY	"	"	"
R523	QRD141J-913SY	91 kΩ	"	"
R524	QRD141J-913SY	"	"	"
R525	QRD141J-513SY	51 kΩ	"	"
R526	QRD141J-513SY	"	"	"
R527	QRD141J-333SY	33 kΩ	"	"
R528	QRD141J-333SY	"	"	"
R529	QRD141J-243SY	24 kΩ	"	"
R530	QRD141J-243SY	"	"	"
R531	QRD141J-682SY	6.8 kΩ	"	"
R532	QRD141J-682SY	"	"	"
R533	QRD141J-682SY	"	"	"
R534	QRD141J-682SY	"	"	"
R535	QRD141J-682SY	"	"	"
R536	QRD141J-682SY	"	"	"
R537	QRD141J-682SY	"	"	"
R538	QRD141J-682SY	"	"	"
R539	QRD141J-682SY	"	"	"
R540	QRD141J-682SY	"	"	"
VR501	QVZ5010-002			Variable (40 Hz)
VR502	QVZ5010-002			" (250 Hz)
VR503	QVZ5010-002			" (1 kHz)
VR504	QVZ5010-002			" (5 kHz)
VR505	QVZ5010-002			" (15 kHz)

Other

Item No.	Part Number	Rating	Description
	QMV5005-007		Pin Plug Ass'y

10-(5) TFM-924 FM/AM Tuner P.C.Board Ass'y

The number of TFM-924 P.C. Board Ass'y varies according to the area employed.

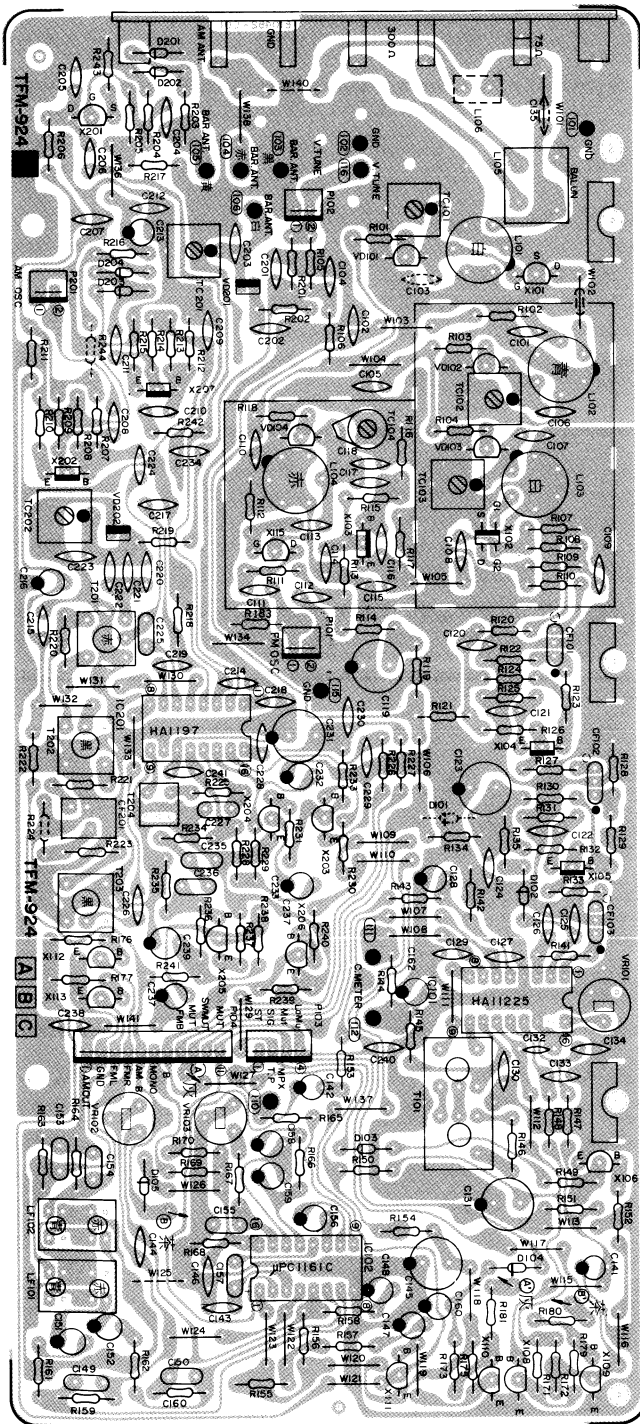

Fig. 22

Note (1):

In should be indicated an area code (A or B) according to the table shown below.

Areas	P.C. Board Ass'y
Australia, U.K. and Europe	TFM-924 <input type="checkbox"/> B
All Other Countries	TFM-924 <input type="checkbox"/> A

Note (2):

The specific symbols (赤, 黒, 白, ... etc.) on a surface of above P.C. Board are actually unrelated to the repair service and are significant denotement in order to process the proper assembly of P.C. Board at the factory.

Transistors

Item No.	Part Number	Rating		Description	
		Pc	fT		Maker
X101	2SK168(E,F)	0.2 W		F.E.T.	Hitachi
X102	3SK73(GR)	0.3 W		"	Toshiba
X103	2SC535(B)	0.1 W	940 MHz	Silicon	Hitachi
X104	2SC535(B,C)	"	"	"	"
X105	2SC535(B,C)	"	"	"	"
X106	2SC458(C,D)	0.2 W	230 MHz	"	"
X108	2SC458(C,D)	"	"	"	"
X109	2SC458(C,D)	"	"	"	"
X110	2SC458(C,D)	"	"	"	"
X111	2SA1029(C,D)	"	200 MHz	"	"
X112	2SD655(E,F)	0.5 W	250 MHz	"	"
X113	2SD655(E,F)	"	"	"	"
X115	2SK165(E)	0.2 W		F.E.T.	"
X201	2SK105(H)	0.25 W		"	NEC
X202	2SC461(B,C)	0.2 W	230 MHz	Silicon	Hitachi
X203	2SC458(C,D)	"	"	"	"
X204	2SC458(C,D)	"	"	"	"
X205	2SC458(C,D)	"	"	"	"
X206	2SD655(E,F)	0.5 W	250 MHz	"	"
X207	2SC461(B,C)	0.2 W	230 MHz	"	"

Integrated Circuits

Item No.	Part Number	Rating		Description	
		Pc			Maker
IC101	HA11225	0.59 W		IC	Hitachi
IC102	UPC1161C			"	NEC
IC201	HA1197	0.45 W		"	Hitachi

Diodes

Item No.	Part Number	Rating	Description	
				Maker
D102	1S2076-31		Silicon	Hitachi
D103	1S2076-31		"	"
D104	1S2076-31		"	"
D105	1S2076-31		"	"
D201	1S2076-31		"	"
D202	1S2076-31		"	"
D203	1S2076-31		"	"
D204	1S2076-31		"	"
VD101	1SV55		V. Cap. Diode	"
VD102	1SV55		"	"
VD103	1SV55		"	"
VD104	1SV55		"	"
VD201	KV1226		"	Toko
VD202	KV1226		"	"

Coils & Transformers

Item No.	Part Number	Rating	Description
L101	E03477-060		RF Coil
L102	E03477-061		"
L103	E03477-060		"
L104	E03477-050		"
L105	E03177-005		Balun Coil
T101	E03793-001		FM Detector Transformer
T201	E03079-45		AM OSC
T202	E03062-42		AM IFT
T203	E03062-42		"
T204	E03062-39		"

Filters

Item No.	Part Number	Rating	Description
CF101	PC022		Ceramic
CF102	PC022		"
CF103	PC022		"
CF201	E03613-021		"
LF101	E03427-020		"
LF102	E03427-020		"

Capacitors

Item No.	Part Number	Rating		Description
C101	QCF31HP-103Z	0.01 μ F	50 V	Ceramic
C102	QCF31HP-103Z	"	"	"
C104	QCF31HP-223Z	0.022 μ F	"	"
C105	QCF31HP-223Z	"	"	"
C106	QCS31HJ-5R0Z	5 pF	"	"
C107	QCS31HJ-5R0Z	"	"	"
C108	QCT25UJ-330Z	33 pF	"	"
C109	QCF31HP-223Z	0.022 μ F	50 V	"
C110	QCF31HP-103Z	0.01 μ F	"	"
C111	QCF31HP-103Z	"	"	"
C112	QCF31HP-103Z	"	"	"
C113	QCT25CH-2R0Z	2 pF	"	"
C114	QCF31HP-103Z	0.01 μ F	50 V	"
C115	QCT25UJ-150Z	15 pF	"	"
C116	QCT25UJ-220Z	22 pF	"	"
C117	QCT25UJ-100Z	10 pF	"	"
C119	QET51CR-227	220 μ F	16 V	Electrolytic
C120	QCF31HP-223Z	0.022 μ F	50 V	Ceramic
C121	QCF31HP-223Z	"	"	"
C122	QCF31HP-223Z	"	"	"
C123	QET61CR-476Z	47 μ F	16 V	Electrolytic
C124	QCF31HP-223Z	0.022 μ F	50 V	Ceramic
C125	QCF31HP-223Z	"	"	"
C126	QCF31HP-223Z	"	"	"
C127	QCS21HJ-330	33 pF	"	"
C128	QET61HR-225Z	2.2 μ F	"	Electrolytic
C129	QCF31HP-223Z	0.022 μ F	"	Ceramic
C130	QCF31HP-223Z	"	"	"
C131	QET51CR-227	220 μ F	16 V	Electrolytic
C132	QCC21EM-473	0.047 μ F	25 V	"
C133	QCF31HP-223Z	0.022 μ F	50 V	Ceramic
C134	QCF31HP-223Z	"	"	"
C142	QET61CR-226Z	22 μ F	16 V	Electrolytic
C143	QCS31HJ-471Z	470 pF	50 V	Ceramic
C144	QCS31HJ-101Z	100 pF	"	"
C145	QET51CR-227	220 μ F	16 V	Electrolytic
C146	QCF31HP-223Z	0.022 μ F	50 V	Ceramic

Capacitors

Item No.	Part Number	Rating		Description
C147	QET61ER-106Z	10 μ F	25 V	Electrolytic
C148	QET61ER-106Z	"	"	"
C149	QFM31HJ-102Z	1000 pF	50 V	Mylar (TFM-924B)
C149	QFM31HJ-152Z	1500 pF	"	" (TFM-924A)
C150	QFM31HJ-102Z	1000 pF	"	" (TFM-924B)
C150	QFM31HJ-152Z	1500 pF	"	" (TFM-924A)
C151	QET61HR-225Z	2.2 μ F	"	Electrolytic
C152	QET61HR-225Z	"	"	"
C153	QFM31HK-182Z	1800 pF	"	Mylar (TFM-924B)
C153	QFM31HK-272Z	2700 pF	"	" (TFM-924A)
C154	QFM31HK-182Z	1800 pF	"	" (TFM-924B)
C154	QFM31HK-272Z	2700 pF	"	" (TFM-924A)
C155	QFP31HJ-471	470 pF	"	"
C156	QEB51HM-224	0.22 μ F	"	Low Leak Current Electrolytic
C157	QFM31HK-473Z	0.047 μ F	"	Mylar
C158	QEB51EM-335	3.3 μ F	25 V	Low Leak Current Electrolytic
C159	QEB51HM-105	1 μ F	50 V	"
C160	QEB51EM-475	4.7 μ F	25 V	"
C162	QEB51HM-684	0.68 μ F	50 V	"
C201	QCF31HP-223Z	0.022 μ F	"	Ceramic
C202	QCF31HP-223Z	"	"	"
C203	QCS31HJ-5R0Z	5 pF	"	"
C204	QCF31HP-223Z	0.022 μ F	"	"
C205	QCS31HJ-470Z	47 pF	"	"
C206	QCF31HP-223Z	0.022 μ F	"	"
C207	QCF31HP-223Z	"	"	"
C208	QCF31HP-223Z	"	"	"
C209	QCF31HP-223Z	"	"	"
C210	QCF31HP-223Z	"	"	"
C211	QCF31HP-223Z	"	"	"
C212	QCF31HP-223Z	"	"	"
C213	QET61HR-105Z	1 μ F	"	Electrolytic
C214	QCF31HP-223Z	0.022 μ F	"	Ceramic
C215	QCF31HP-223Z	"	"	"
C216	QET61CR-476Z	47 μ F	16 V	Electrolytic
C217	QCS31HJ-470Z	47 pF	50 V	Ceramic
C218	QCF31HP-223Z	0.022 μ F	"	"
C219	QCF31HP-223Z	"	"	"
C220	QCS31HJ-271Z	270 pF	"	"
C221	QCS31HJ-181Z	180 pF	"	"
C222	QCS31HJ-100Z	10 pF	"	"
C223	QCT25UJ-180Z	18 pF	"	"
C224	QCS31HJ-101Z	100 pF	50 V	"
C225	QFM31HK-103Z	0.01 μ F	"	Mylar
C226	QCF31HP-223Z	0.022 μ F	"	Ceramic
C227	QFM31HK-102Z	1000 pF	"	Mylar
C228	QCC31EM-473Z	0.047 μ F	25 V	"
C229	QCF31HP-223Z	0.022 μ F	50 V	Ceramic
C230	QCF31HP-223Z	"	"	"
C231	QET61CR-107Z	100 μ F	16 V	Electrolytic
C232	QET61HR-105Z	1 μ F	50 V	"
C233	QET61ER-106Z	10 μ F	25 V	"
C234	QCF31HP-223Z	0.022 μ F	50 V	Ceramic
C235	QFM31HK-472Z	4700 pF	"	Mylar
C236	QFM31HK-333Z	0.033 μ F	"	"
C237	QET61HR-105Z	1 μ F	"	Electrolytic
C238	QCF31HP-103Z	0.01 μ F	"	Ceramic
C239	QET61CR-476Z	47 μ F	16 V	Electrolytic
C240	QCF31HP-223Z	0.022 μ F	50 V	Ceramic
C241	QCF31HP-223Z	"	"	"
TC101	QAT2001-001			Trimmer
TC102	QAT2001-001			"
TC103	QAT2001-001			"
TC104	QAT3001-005			"
TC201	QAT2001-005			"
TC202	QAT2001-005			"

Resistors

Item No.	Part Number	Rating		Description
R101	QRD141J-473SY	47 kΩ	1/4 W	Carbon
R102	QRD141J-221SY	220 Ω	"	"
R103	QRD141J-473SY	47 kΩ	"	"
R104	QRD141J-473SY	"	"	"
R105	QRD141J-222SY	2.2 kΩ	"	"
R106	QRD141J-103SY	10 kΩ	"	"
R107	QRD141J-222SY	2.2 kΩ	"	"
R108	QRD141J-563SY	56 kΩ	"	"
R109	QRD141J-391SY	390 Ω	"	"
R110	QRD141J-470SY	47 Ω	"	"
R111	QRD141J-102SY	1 kΩ	"	"
R112	QRD141J-105SY	1 MΩ	"	"
R113	QRD141J-101SY	100 Ω	"	"
R114	QRD141J-470SY	47 Ω	"	"
R115	QRD141J-103SY	10 kΩ	"	"
R116	QRD141J-103SY	"	"	"
R117	QRD141J-122SY	1.2 kΩ	"	"
R118	QRD141J-473SY	47 kΩ	"	"
R119	QRD141J-221SY	220 Ω	"	"
R120	QRD149J-220S	22 Ω	"	" ⚠
R121	QRD149J-220S	"	"	" ⚠
R122	QRD141J-681SY	680 Ω	"	"
R123	QRD141J-101SY	100 Ω	"	"
R124	QRD141J-392SY	3.9 kΩ	"	"
R125	QRD141J-561SY	560 Ω	"	"
R126	QRD141J-391SY	390 Ω	"	"
R127	QRD141J-101SY	100 Ω	"	"
R128	QRD141J-681SY	680 Ω	"	"
R129	QRD141J-101SY	100 Ω	"	"
R130	QRD141J-392SY	3.9 kΩ	"	"
R131	QRD141J-102SY	1 kΩ	"	"
R132	QRD141J-391SY	390 Ω	"	"
R133	QRD141J-101SY	100 Ω	"	"
R134	QRD141J-221SY	220 Ω	"	"
R135	QRD141J-103SY	10 kΩ	"	"
R141	QRD141J-391SY	390 Ω	"	"
R142	QRD141J-473SY	47 kΩ	"	"
R143	QRD141J-123SY	12 kΩ	"	"
R144	QRD141J-561SY	560 Ω	"	"
R145	QRD141J-273SY	27 kΩ	"	"
R146	QRD141J-332SY	3.3 kΩ	"	"
R147	QRD141J-222SY	2.2 kΩ	"	"
R148	QRD141J-563SY	56 kΩ	"	"
R149	QRD141J-473SY	47 kΩ	"	"
R150	QRD149J-330S	33 Ω	"	" ⚠
R151	QRD141J-563SY	56 kΩ	"	"
R152	QRD141J-333SY	33 kΩ	"	"
R153	QRD141J-563SY	56 kΩ	"	"
R154	QRD149J-220S	22 Ω	"	" ⚠
R155	QRD141J-223SY	22 kΩ	"	"
R156	QRD141J-223SY	"	"	"
R157	QRD141J-103SY	10 kΩ	"	"
R158	QRD141J-103SY	"	"	"
R159	QRD141J-473SY	47 kΩ	"	"
R160	QRD141J-473SY	"	"	"
R161	QRD141J-332SY	3.3 kΩ	"	"
R162	QRD141J-332SY	"	"	"
R163	QRD141J-682SY	6.8 kΩ	"	"
R164	QRD141J-682SY	"	"	"
R165	QRD141J-271SY	270 Ω	"	"
R166	QRD141J-102SY	1 kΩ	"	"
R167	QRD141J-163SY	16 kΩ	"	"
R168	QRD141J-223SY	22 kΩ	"	"
R169	QRD141J-333SY	33 kΩ	"	"
R170	QRD141J-333SY	"	"	"
R171	QRD141J-103SY	10 kΩ	"	"
R172	QRD141J-472SY	4.7 kΩ	"	"

Resistors

Item No.	Part Number	Rating		Description
R173	QRD141J-223SY	22 kΩ	1/4 W	Carbon
R175	QRD141J-223SY	"	"	"
R176	QRD141J-563SY	56 kΩ	"	"
R177	QRD141J-563SY	"	"	"
R179	QRD141J-223SY	22 kΩ	"	"
R180	QRD141J-223SY	"	"	"
R181	QRD141J-224SY	220kΩ	"	"
R202	QRD141J-103SY	10 kΩ	"	"
R203	QRD141J-102SY	1 kΩ	"	"
R204	QRD141J-105SY	1 MΩ	"	"
R205	QRD141J-824SY	820 kΩ	"	"
R206	QRD141J-561SY	560 Ω	"	"
R207	QRD141J-334SY	330 kΩ	"	"
R208	QRD141J-683SY	68 kΩ	"	"
R209	QRD141J-102SY	1 kΩ	"	"
R210	QRD141J-221SY	220 Ω	"	"
R211	QRD141J-221SY	"	"	"
R212	QRD141J-683SY	68 kΩ	"	"
R213	QRD141J-334SY	330 kΩ	"	"
R214	QRD141J-562SY	5.6 kΩ	"	"
R215	QRD141J-331SY	330 Ω	"	"
R216	QRD141J-561SY	560 Ω	"	"
R217	QRD141J-104SY	100 kΩ	"	"
R218	QRD141J-152SY	1.5 kΩ	"	"
R219	QRD141J-473SY	47 kΩ	"	"
R220	QRD141J-102SY	1 kΩ	"	"
R221	QRD141J-221SY	220 Ω	"	"
R222	QRD149J-101S	100 Ω	"	" ⚠
R223	QRD141J-561SY	560 Ω	"	"
R225	QRD141J-331SY	330 Ω	"	"
R226	QRD141J-562SY	5.6 kΩ	"	"
R227	QRD149J-101S	100 Ω	"	" ⚠
R228	QRD141J-103SY	10 kΩ	"	"
R229	QRD141J-103SY	"	"	"
R230	QRD141J-563SY	56 kΩ	"	"
R231	QRD141J-563SY	"	"	"
R233	QRD141J-103SY	10 kΩ	"	"
R234	QRD141J-472SY	4.7 kΩ	"	"
R235	QRD141J-823SY	82 kΩ	"	"
R236	QRD141J-274SY	270 kΩ	"	"
R237	QRD141J-102SY	1 kΩ	"	"
R238	QRD141J-152SY	1.5 kΩ	"	"
R239	QRD141J-563SY	56 kΩ	"	"
R240	QRD141J-103SY	10 kΩ	"	"
R241	QRD141J-221SY	220 Ω	"	"
R242	QRD141J-472SY	4.7 kΩ	"	"
VR101	QVP4A0B-473	47 kΩ	"	Variable
VR102	QVP4A0B-474	470 kΩ	"	"
VR103	QVP4A0B-472	4.7 kΩ	"	"

Others

Item No.	Part Number	Rating	Description
	E03572-021		Antenna Terminal
	E300847-001		Shield Plate
	E300848-001		"
	E65396-001		Ground Plate
	QMV5005-002		2-pins Plug Ass'y
	QMV5005-004		4-pins Plug Ass'y
	QMV5005-011		11-pins Plug Ass'y

11. Accessories List

Item No.	Part Number	Description	Q'ty
1	E30580-827A	Instruction Book	1
2	See next page	Warranty Card	1
3	E03614-004	FM Antenna	1
4	BT20042	Service Procedures (for U.S.A. only)	1
5	E41202-2	Envelope for Instruction Book	1

12. Packing Materials and Part Numbers

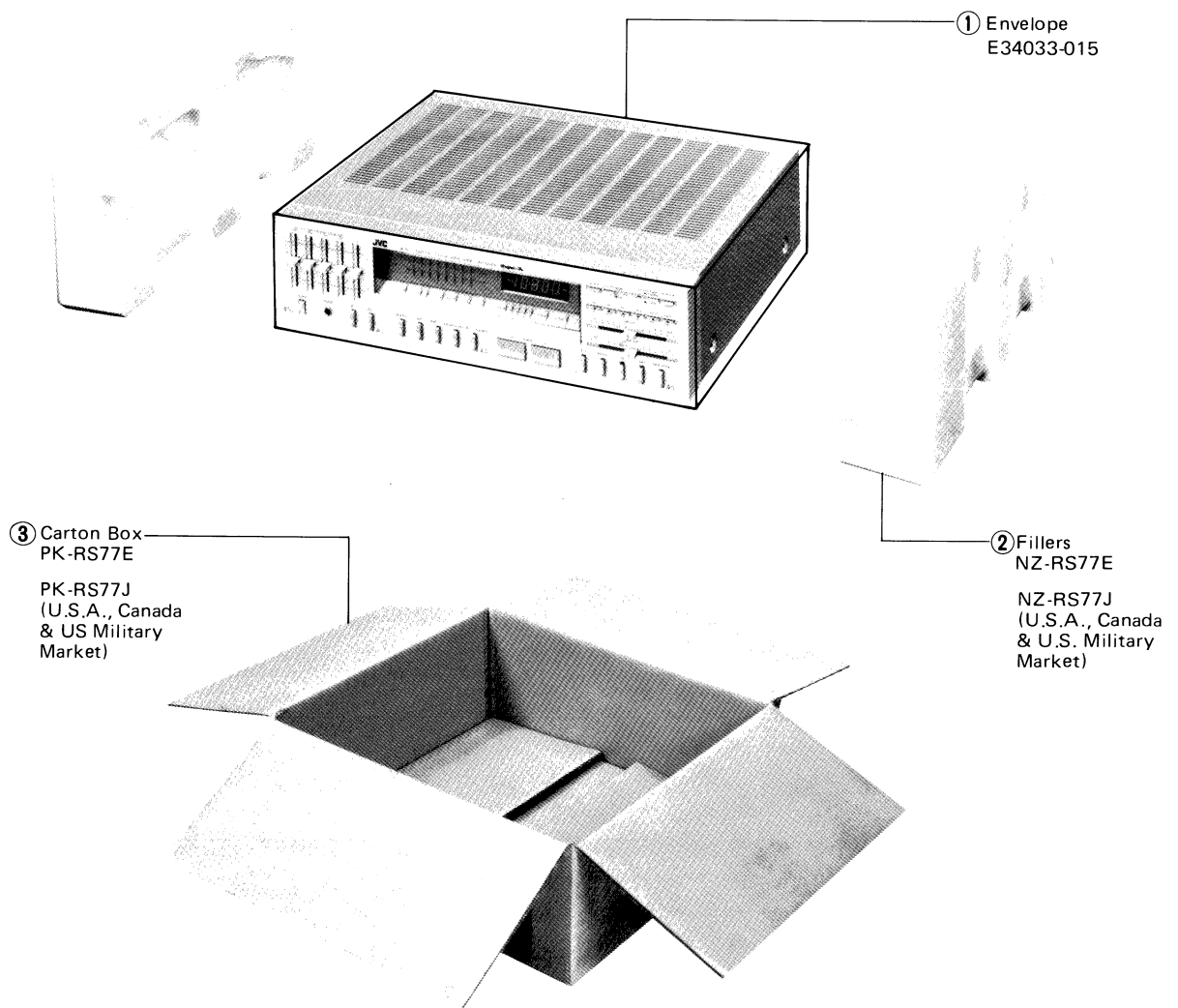

Fig. 23

13. R-S77 Schematic Diagram

A

B

C

D

1

2

3

4

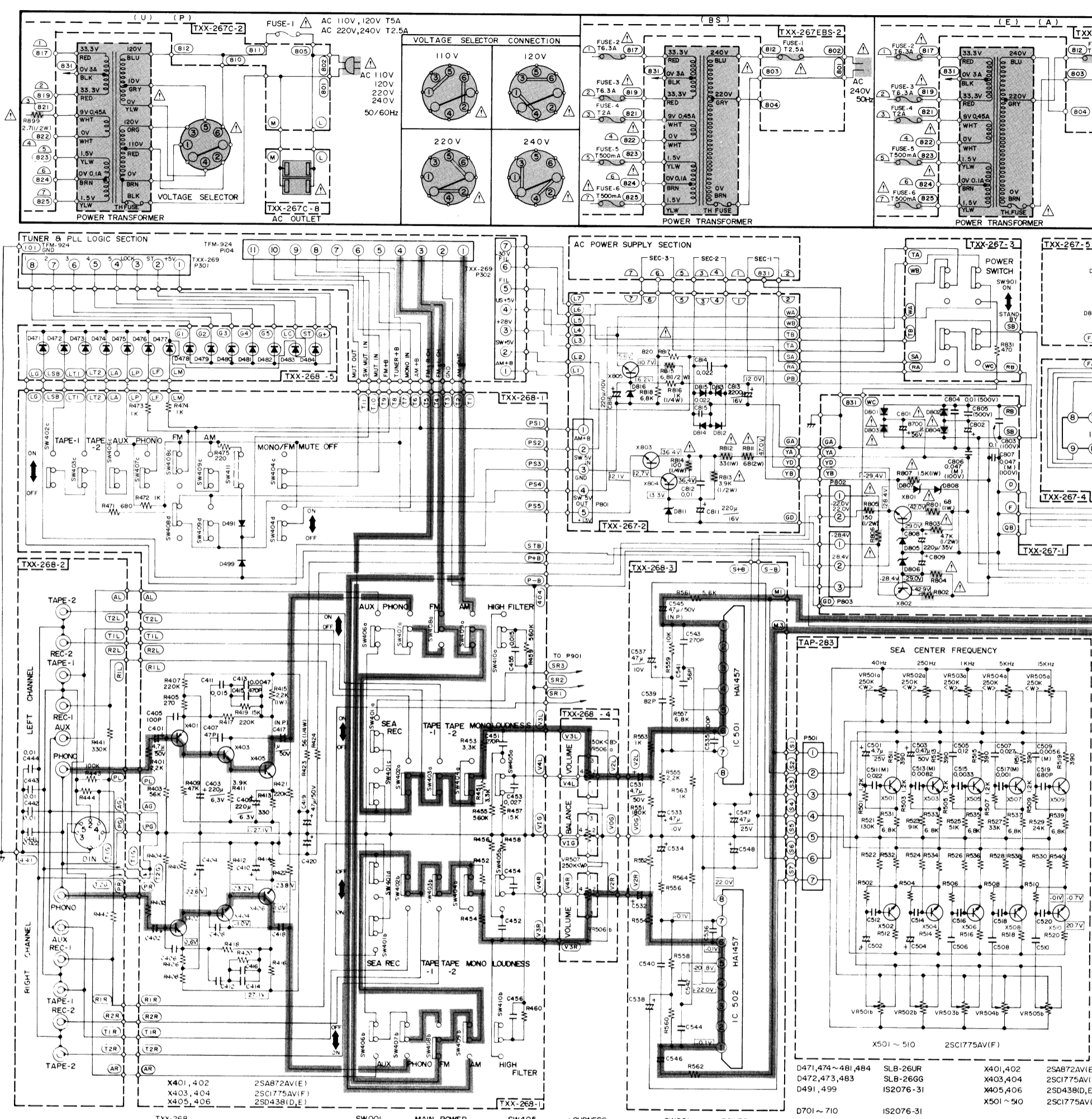

- | | | | | | |
|--|---|---|--|--|---|
| <p>TXX-267</p> <ul style="list-style-type: none"> -1 Super A AMP C.B. Assy -2 Fuse, Power Supply C.B. Assy -3 SPK. Stand by Switch C.B. Assy -4 Power Indicator Driver C.B. Assy -5 Power Indicator LED C.B. Assy -6 SPK. Terminal C.B. Assy -7 Head Phones C.B. Assy -8 AC Outlet C.B. Assy <p>TXX-269</p> <p>LOGIC C.B. Assy</p> | <p>TXX-268</p> <ul style="list-style-type: none"> -1 Switch EQ AMP C.B. Assy -2 Phn Jack C.B. Assy -3 SEA AMP C.B. Assy -4 Volume Balance C.B. Assy -5 LED Indicator C.B. Assy <p>TAP-283</p> <p>SEA Unit C.B. Assy</p> <p>TFM-924</p> <p>TUNER C.B. Assy</p> | <p>SW001 MAIN POWER</p> <p>SW401 SEA REC</p> <p>SW402 TAPE-1</p> <p>SW403 TAPE-2</p> <p>SW404 MONO, FM MUTE OFF</p> <p>SW405 LOUDNESS</p> <p>SW406 AUX</p> <p>SW407 PHONO</p> <p>SW408 FM</p> <p>SW409 AM</p> <p>SW410 HIGH FILTER</p> | <p>SW901 POWER</p> <p>SW902 SPK-1</p> <p>SW903 SPK-2</p> <p>J901 HEAD PHONES</p> | <p>D701 ~ 710 IS2076-31</p> <p>D801 ~ 804 30D2FA-S</p> <p>D805, 806 RD30EB3</p> <p>D807, 808 RD15EB3</p> <p>D811 RD13EB3</p> <p>D812 ~ 815 ERB12-02RKL1</p> <p>D816 RD6.2EB3</p> <p>D851 ~ 866 SLB-266G</p> <p>D867 ~ 870 IS2076-31</p> <p>D901, 902 IS2076-31</p> | <p>X401, 402 2SA872AV(E)</p> <p>X403, 404 2SC1775AV(F)</p> <p>X405, 406 2SD438(D, E)</p> <p>X701 ~ 704 2SC1775AV(F)</p> <p>X705, 706 2SC1775AV(F)</p> <p>X707 ~ 710 2SA949(O, Y)</p> <p>X711, 712 2SA1029(C)</p> <p>X713, 714 2SC2229(O, Y)</p> <p>X715, 716 2SC2546(E)</p> <p>X717, 718 2SC1775AV(F)</p> <p>X719, 720 2SA872AV(E)</p> <p>X721, 722 2SD669A(B, C)</p> <p>X723, 724 2SB649A(B, C)</p> <p>X725, 726 2SD485L(B, F)</p> |
|--|---|---|--|--|---|

A

B

C

D

Printed Circuit Board Ass'y Locations

P.C. Board Ass'y	Description	Page
TXX-267	Main Amp., Power Supply and Other Functions Split P.C. Board Ass'y	10
TXX-268	Equalizer, S.E.A. and Other Functions Split P.C. Board Ass'y	13
TXX-269	Logic and Counter P.C. Board Ass'y	15
TAP-283	S.E.A. Control P.C. Board Ass'y	17
TFM-924	FM/AM Tuner P.C. Board Ass'y	18

Notes:

1. indicates signal path.
 2. indicates positive B power supply.
 3. indicates negative B Power supply
 4. Parts in red indicate transistors or ICs.
 5. Voltage values in (9.2) are positive.
 6. Voltage values in (-23.0) are negative.
 7. This is the standard circuit diagram.
- The design and contents are subject to change without notice.

D

E

F

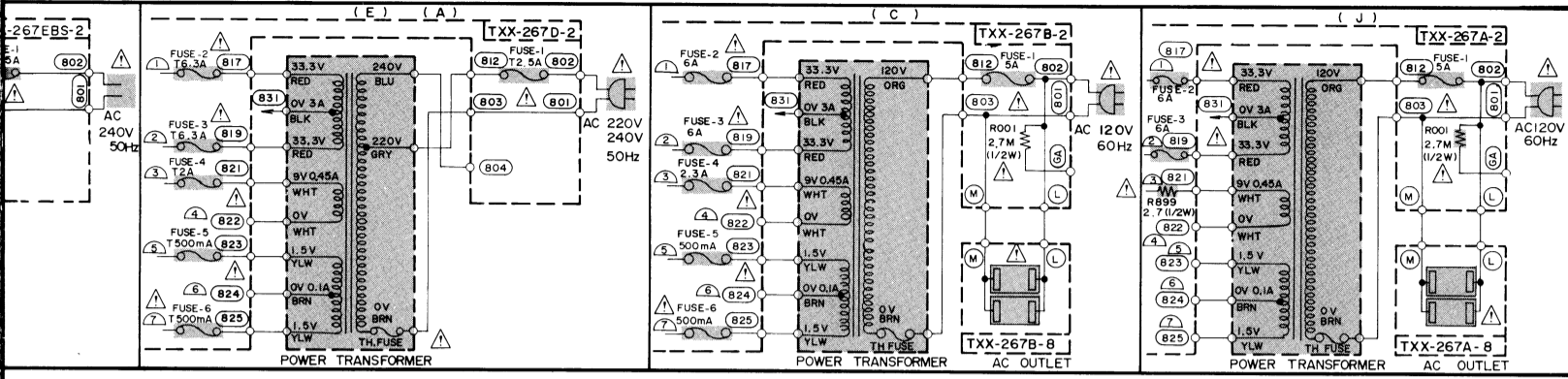

1

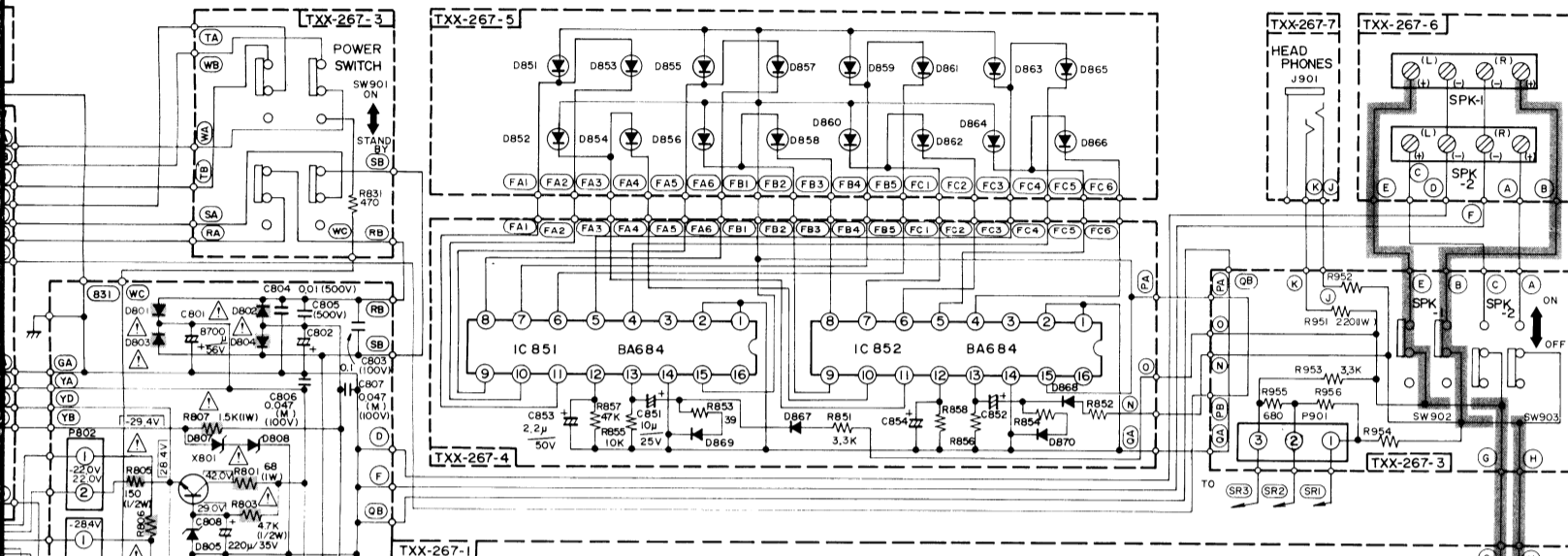

2

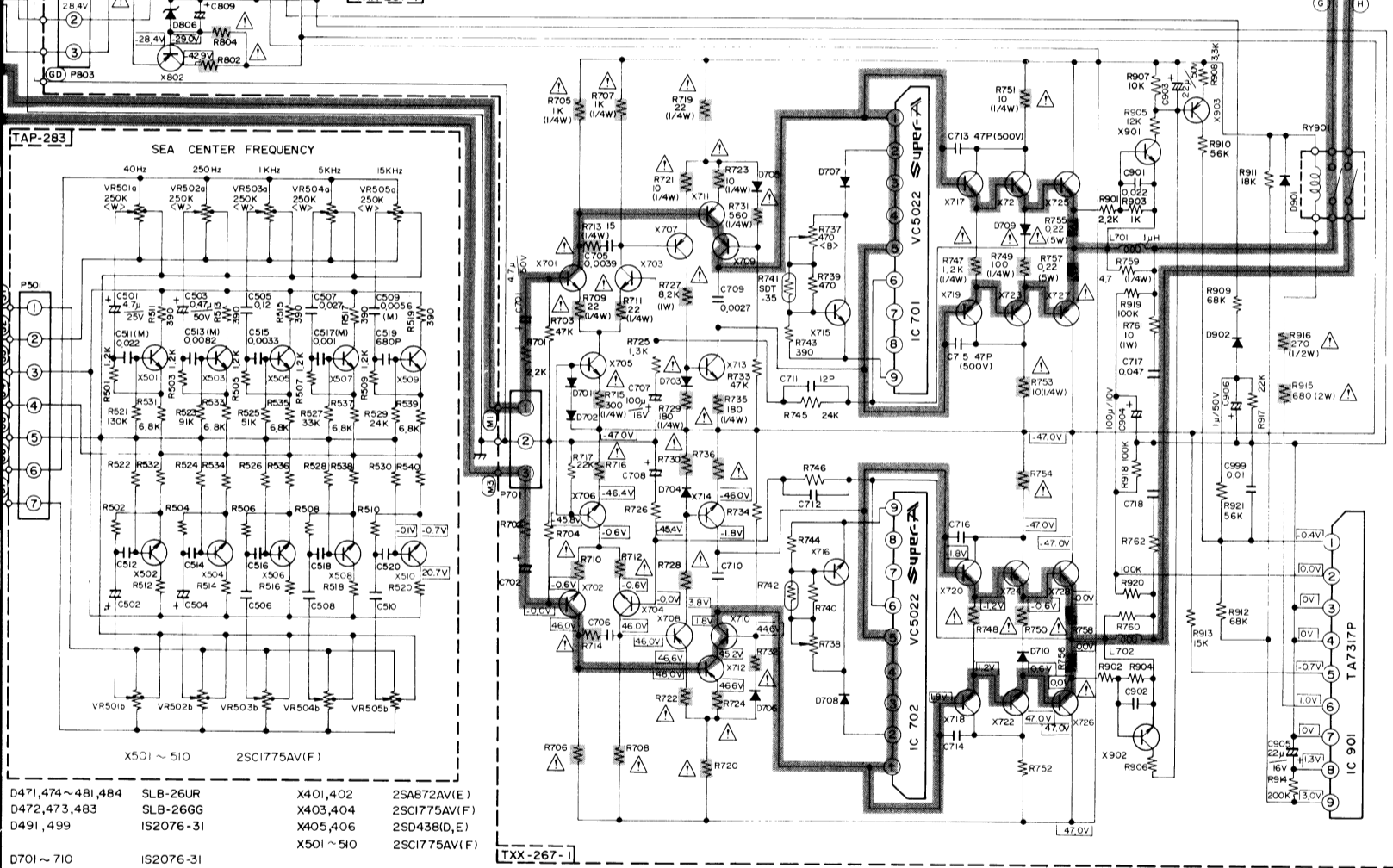

3

D471, 474 ~ 481, 484	SLB-26UR	X401, 402	2SA872AV(E)
D472, 473, 483	SLB-26GG	X403, 404	2SC1775AV(F)
D491, 499	IS2076-3I	X405, 406	2SD438(D,E)
D701 ~ 710	IS2076-3I	X501 ~ 510	2SC1775AV(F)
D801 ~ 804	30D2FA-S	X701 ~ 704	2SC1775AV(F)
D805, 806	RD30EB3	X705, 706	2SC1775AV(F)
D807, 808	RD13EB3	X707 ~ 710	2SA949(O,Y)
D811	RD13EB3	X711, 712	2SA1029(C)
D812 ~ 815	ERB12-02RKL1	X713, 714	2SC2229(O,Y)
D816	RD6.2EB3	X715, 716	2SC2546(E)
D851 ~ 866	SLB-26GG	X717, 718	2SC1775AV(F)
D867 ~ 870	IS2076-3I	X719, 720	2SA872AV(E)
D901, 902	IS2076-3I	X721, 722	2SD669A(B,C)
		X723, 724	2SB649A(B,C)
		X725, 726	2SD845LB(R,O)

X727, 728	2SB755LB(R,O)
X801, 803, 805	2SD313V(D,E)
X802	2SB507V(D,E)
X804	2SC1775AV(F)
X901, 902	2SC1775AV(F)
X903	2SA872AV(E)

4

D

E

F

ge without

FM/AM TUNER & P.L.L. SYNTHESIZER SECTION

1
2
3
4

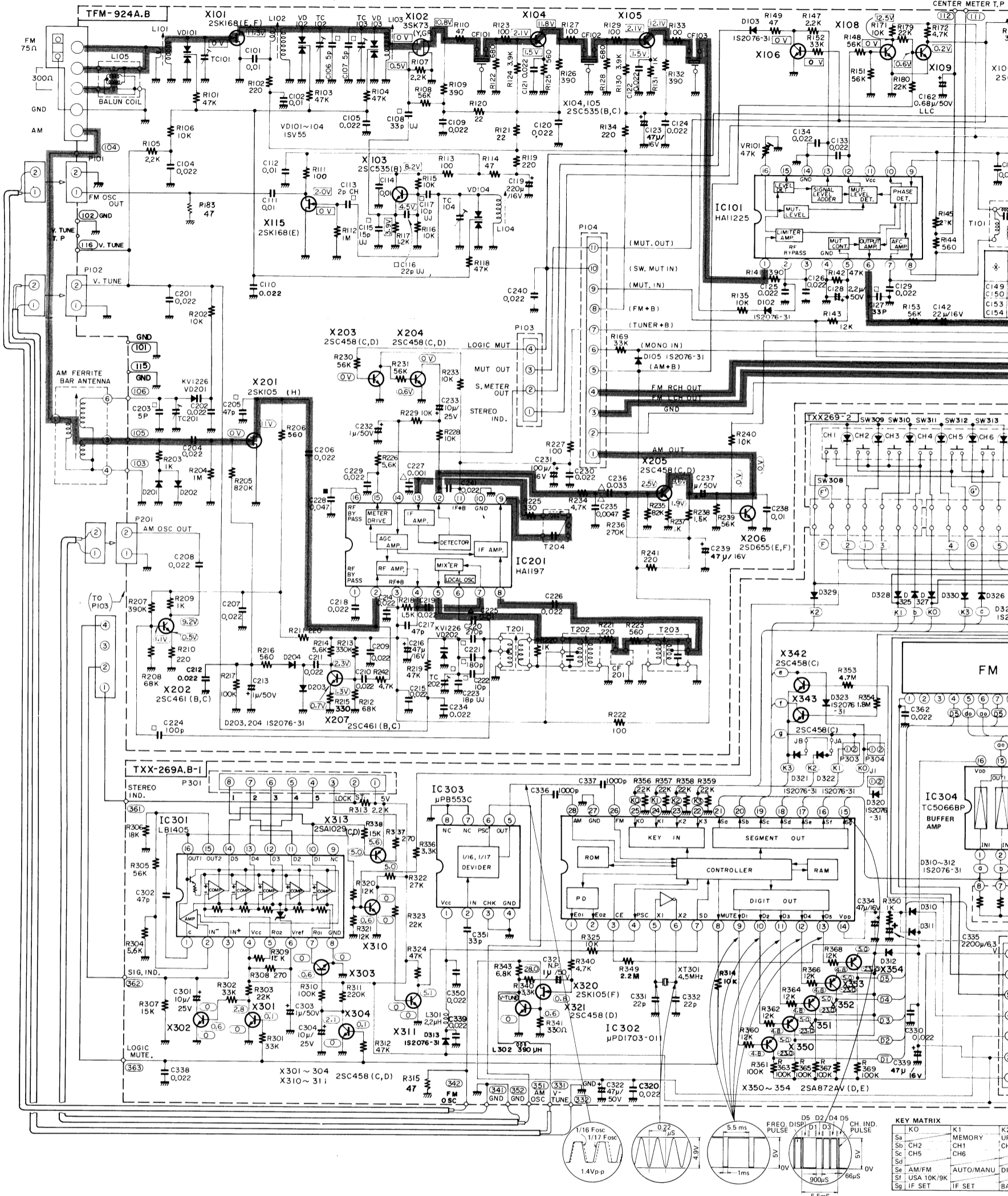

Printed Circuit Board Ass'y Locations

P.C. Board Ass'y	Description	Page
TXX-267	Main Amp., Power Supply and Other Functions Split P.C. Board Ass'y	10
TXX-268	Equalizer, S.E.A. and Other Functions Split P.C. Board Ass'y	13
TXX-269	Logic and Counter P.C. Board Ass'y	15
TAP-283	S.E.A. Control P.C. Board Ass'y	17
TFM-924	FM/AM Tuner P.C. Board Ass'y	18

Notes:

- When replacing the parts in the darkened area and those marked with , be sure to use the designated parts to ensure safety.
- indicates signal path.
- indicates positive B power supply.
- indicates negative B power supply.
- Parts in red indicate transistors or ICs.
- Voltage values in [5.6 V] are positive.
- Voltage values in [-1.8 V] are negative.
- This is the standard circuit diagram. The design and contents are subject to change without notice.

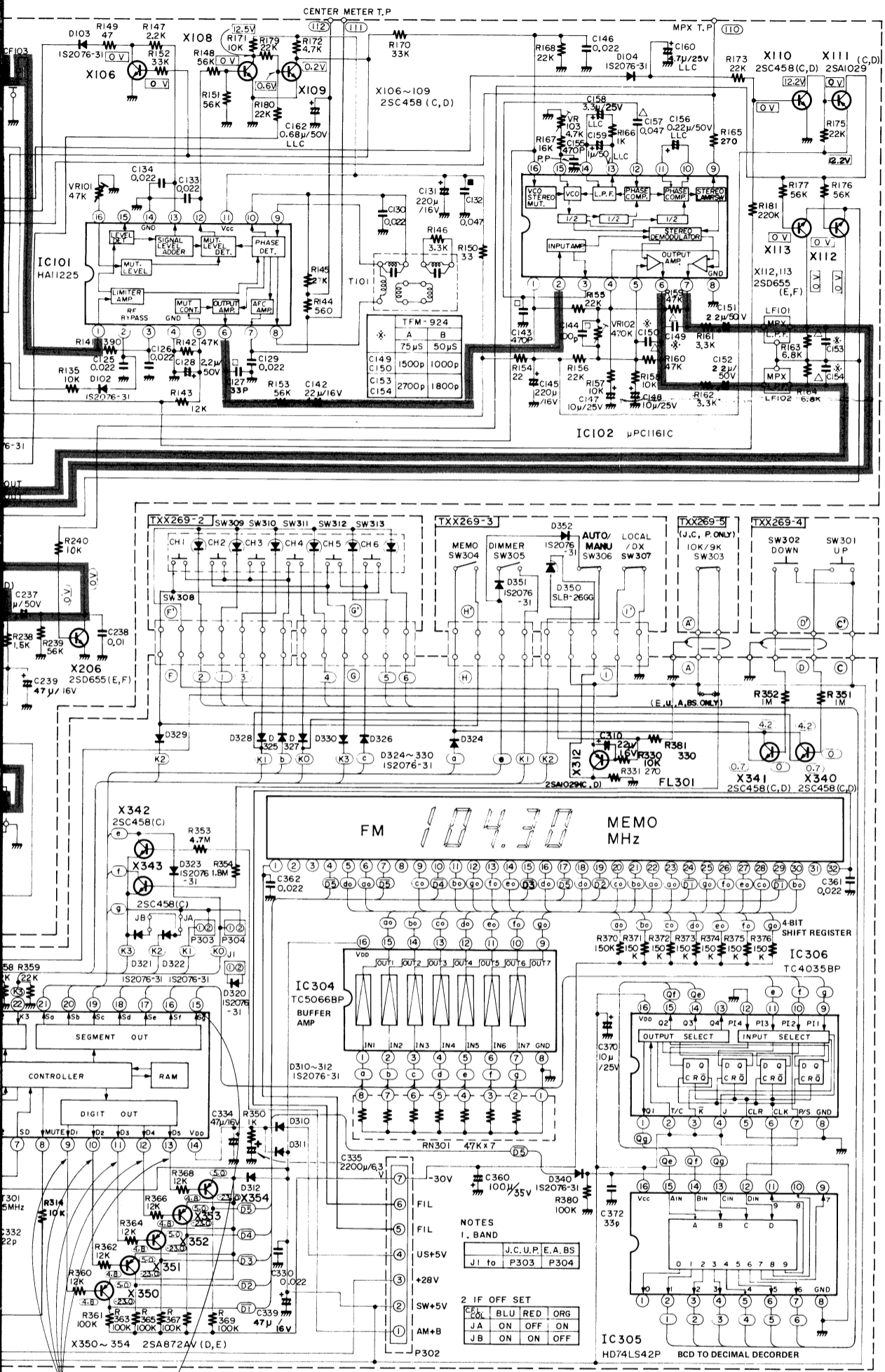

IC PIN VOLTAGE (V) (IC101, 102, 301, 302, 303, 304, 305, 306, FM, CH1 SELECT, AM SELECT)

PIN NO.	IC101	IC102	IC201	IC301	IC302	IC304	IC305	IC306	IC307
1	1.9	12.2	5.1	0.6	5.0	SEG. a	Ac	Qg	V-TUNE.
2	1.9	2.3	2.2	0	2.6	SEG. b	At	5.6	V-TUNE.
3	1.9	5.4	11.9	SIG. IN	0	SEG. c	A2	5.6	5.0
4	0(GND)	10.1	9.4	5.6	0(GND)	SEG. d	A3	5.6	0.2
5	4.4	10.1	11.9	2.8	2.0	SEG. e	A4	0(GND)	1.8
6	5.6	5.4	3.7	2.8	0.2	SEG. f	A5	0(GND)	1.8
7	5.6	5.4	1.3	0	0(NC)	SEG. g	A6	0(GND)	4.5 (STOP)
8	5.6	0(GND)	2.9	0(GND)	0(NC)	0(GND)	A6	0(GND)	0.1 (STOP)
9	5.6	5.3	7.8	0(NC)		SEG. ge	A7	SEG. g	DIG. 1
10	5.6	2.3	0(GND)	D1		SEG. fe	A8	SEG. f	DIG. 2
11	11.9	2.3	11.4	D2		SEG. ee	A9	SEG. e	DIG. 3
12	3.2	2.3	1.6	D3		SEG. de	A9	0(GND)	DIG. 4
13	0	2.3	0.7	D4		SEG. ce	Qg	0	DIG. 5
14	0(GND)	2.3	1.6	D5		SEG. be	Qf	Qe	5.0
15	4.8	3.4	0	0		SEG. ae	Qe	Qf	SEG. f
16	3.6	2.7	0.9	COMP		5.6	5.6	5.6	SEG. f

(NOTE)
 - CAPACITOR -
 NON MARK --- 50V CERAMIC (YZ)
 □ --- 25V " "
 △ --- 50V MYCAR " "
 --- E. CAPACITOR
 --- E. CAPACITOR (L.L.C.)
 --- E. CAPACITOR (NON. POLER)

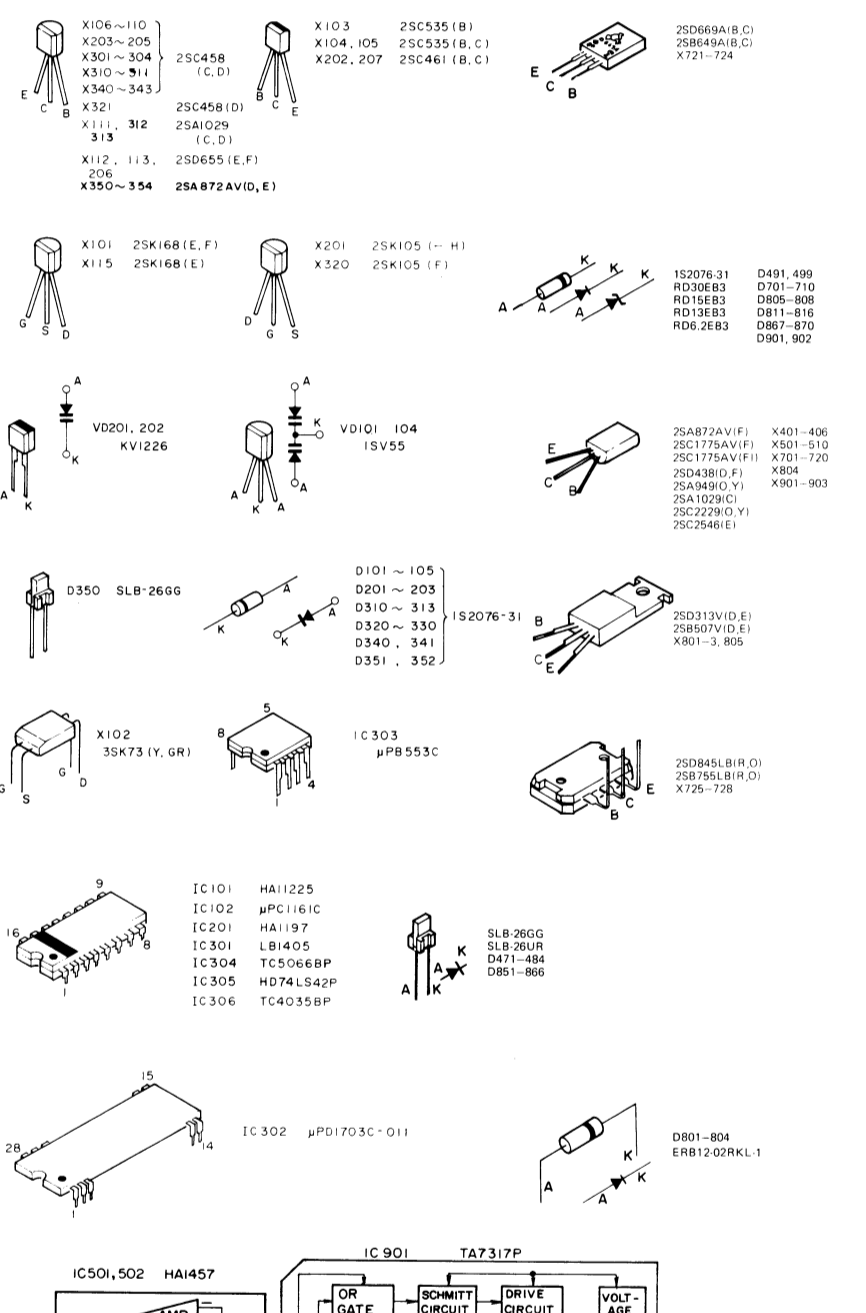

in the darkened area and
 sure to use the designated parts
 power supply.
 power supply.
 tors or ICs.
 positive.
 negative.
 diagram.
 are subject to change without

14. Parts List with Specified Numbers for Designated Areas

Page	Item No.	Description	U.S.A. and Canada	U.K.	Australia and Europe	U.S. Military Market and Other Countries
5	4-(1)	Power Transformer \triangle	E03077-57B (U.S.A.) E03077-57D (Canada)	E03077-57EBS	E03077-57E	E03077-57C
5	4-(3)	Voltage Selector \triangle	—	—	—	QSR0085-001U
5	4-(3)	Fuse Holder \triangle	—	—	—	QMG0301-003
		Fuses — Primary \triangle (Fuse-1)	QMF61U1-5R0 (5.0 A, U.S.A.) QMF60R1-5R0 (5.0 A, Canada)	QMF51A2-2R5LBS (T2.5 A)	QMF51A2-2R5L (T2.5 A)	QMF51A2-2R5L (T2.5 A) QMF51A2-5R0S (T5.0 A)
		— Secondary-1 \triangle (Fuse-2, 3)	QMF61U1-6R0 (6.0A, U.S.A.) QMF60R1-6R0 (6.0 A, Canada)	QMF51A2-6R3SBS (T6.3 A)	QMF51A2-6R3S (T6.3 A)	—
		-2 \triangle (Fuse-4)	QMF60R1-2R3 (2.3 A, Canada)	QMF51A2-2R0LBS (T2.0 A)	QMF51A2-2R0L (T2.0 A)	—
		-3 \triangle (Fuse-5, 6)	QMF60R1-R50 (0.5 A, Canada)	QMF51A2-R50LBS (T0.5 A)	QMF51A2-R50L (T0.5 A)	—
5	4-(3)	Power Cord \triangle	QMP1200-200	QMP9017-008BS	QMP2560-244 (Australia) QMP3900-200 (Europe)	QMP7600-250
5	4-(3)	Cord Stopper (Power) \triangle	QHS3876-162	QHS3876-162BS	QHS3876-162	QHS3876-162
10		AC Outlet \triangle	QMC0437-001	—	—	QMC0437-001
13		Main Amp., Power Supply & Other Function P.C. Board Ass'y \triangle	TXX-267A (U.S.A.) TXX-267B (Canada)	TXX-267EBS	TXX-267D	TXX-267C
15		Equalizer, S.E.A. & Other Function P.C. Board Ass'y	TXX-268A	TXX-268B	TXX-268B	TXX-268A
15		Logic & Counter P.C. Board Ass'y	TXX-269A	TXX-269B	TXX-269B	TXX-269A (U.S. Military Market)
18		FM/AM Tuner P.C. Board Ass'y	TFM-924A	TFM-924B	TFM-924B	TFM-924A
		Front Panel Ass'y	EFP-RS77J	EFP-RS77E	EFP-RS77E	EFP-RS77J (U.S. Military Market)
4	3-(1)	Top Cover (Metal)	E23469-001	E23469-002	E23469-002	E23469-001 (U.S. Military Market)
4	3-(1)	Cosmetic Board (L)	ED92944-001	—	—	E23469-002 (Other Countries)
4	3-(1)	Cosmetic Board (R)	ED92944-002	—	—	ED92944-001 (U.S. Military Market)
5	4-(3)	Rear Panel	E23467-001	E23467-002	E23467-002	ED92944-002 (U.S. Military Market)
5	4-(3)	Siemens Plug	—	—	—	E23467-001
24	12	Warranty Card	BT20032B (U.S.A.) BT20025C (Canada)	BT20013C	BT20029B (Australia)	E04056 BT20032B (U.S. Military Market)
12	R761,2	Resistor	QRX017J-100S	QRZ0049-100	QRZ0049-100	QRX017J-100S
13	R899	Carbon Resistor	QRD129J-2R7 (U.S.A.)	—	—	QRD129J-2R7

\triangle Safety Parts

Power Specifications

Areas	Line Voltage & Frequency	Power Consumption
U.S.A. and Canada	AC 120 V, 60 Hz	280 W 350 VA
Europe	AC 220 V~, 50 Hz	590 W
Australia and U.K.	AC 240 V~, 50 Hz	590 W
Other Areas	AC 110/120/220/240 V~ Selectable, 50/60 Hz	590 W